

JBC

www.jbctools.com



Premium 4 Tools Rework station with Pneumatic Pump

Ref. DMVE-A

Packing List

The following items should be included:

- | | | |
|----------------------------------------------------------------------------------------------|----------------------------------------------------------------|-----------------------------------------------|
| DME Control Unit 1 unit
Ref. DME-1A (120V)
DME-2A (230V)
DME-9A (100V) | Pneumatic Desoldering Module 1 unit
Ref. MVE-A | Tip Cleaner1 unit
Ref. CL9885 |
|----------------------------------------------------------------------------------------------|----------------------------------------------------------------|-----------------------------------------------|



- | | | | |
|-----------------------------------------------------------|-----------------------------------------|------------------------------------------------------|-----------------------------------------|
| General Purpose Handle 1 unit
Ref. T245-A | Stand 1 unit
Ref. AD-SD | Desoldering Iron 1 unit
Ref. DR560-A | Stand 1 unit
Ref. DR-SD |
|-----------------------------------------------------------|-----------------------------------------|------------------------------------------------------|-----------------------------------------|



- | | | |
|------------------------------------------|------------------------------------------------|---------------------------------------------------|
| Sponge 1 unit
Ref. S0354 | Metal Brush 1 unit
Ref. CL6217 | Union Flanges 1 unit
Ref. 0011356 |
|------------------------------------------|------------------------------------------------|---------------------------------------------------|



- | | | |
|--------------------------------------------------|--------------------------------------------------|-----------------------------------------------------------------------------|
| Stand Cable 2 units
Ref. 0011283 | Module Cable 1 unit
Ref. 0014874 | Power cord 1 unit
Ref. 0010569 (230V)
0013671 (100/120V) |
|--------------------------------------------------|--------------------------------------------------|-----------------------------------------------------------------------------|



DR560 Accessories

Ref. 0010211

- | | |
|------------------------------------------------------|-----------------------------------------------------------|
| Tip cleaning set 1 unit
Ref. 0965970 | Long Tip Cleaning set 1 unit
Ref. 0965760 |
|------------------------------------------------------|-----------------------------------------------------------|

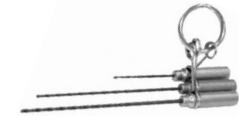

- | | | |
|-----------------------------------------------------------------|-------------------------------------------------|---------------------------------------------|
| Tips 3 units
Ref. C560005
C560013
C560004 | Tin deposit 1 unit
Ref. 0812620 | Spanner 1 unit
Ref. 0780550 |
|-----------------------------------------------------------------|-------------------------------------------------|---------------------------------------------|



- | | | |
|---------------------------------------------------------------------------------|---------------------------------------------------|-------------------------------------------------------|
| Filter Box 1 unit
Ref. 0780840
<i>It contains 10 filters</i> | Internal gasket 2 u.
Ref. 0812360 | Metal tin deposit 1 unit
Ref. 0812630 |
|---------------------------------------------------------------------------------|---------------------------------------------------|-------------------------------------------------------|



- | | | |
|----------------------------------------------------------------------|---------------------------------------------------------------------------------|----------------------------------------------------|
| Cartridges 2 units
Ref. C245903 (x1)
C245906 (x1) | Filter Box 1 unit
Ref. 0005966
<i>It contains 50 filters</i> | Cleaning stick 1 unit
Ref. 0786640 |
|----------------------------------------------------------------------|---------------------------------------------------------------------------------|----------------------------------------------------|



- | |
|----------------------------------------------------|
| Venturi Filter 1 unit
Ref. 0008446 |
|----------------------------------------------------|



- | | |
|------------------------------------------------------------------------------------|----------------------------------------------------|
| Cotton Filter 1 unit
Ref. 0781046
<i>It contains 10 filters</i> | Suction Filter 1 unit
Ref. 0821830 |
|------------------------------------------------------------------------------------|----------------------------------------------------|



- | |
|--------------------------------------------|
| Manual 1 unit
Ref. 0016078 |
|--------------------------------------------|



Adjustable Stands

Cable collector
Keeps working area free of cable.

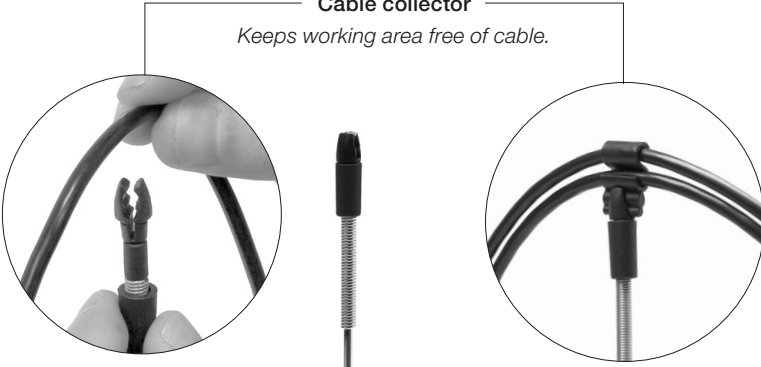

Quick tip changer
Permits switching cartridges without interrupting your work.



Stand
Ref. AD-SD

Quick tip changer
Holding tip system for easy change.



Stand
Ref. DR-SD

Adjustable tool holder
Suits your work position.

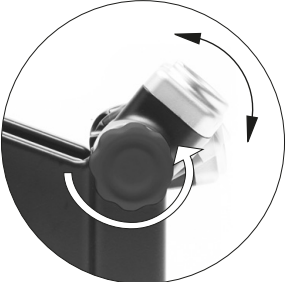

Adjustable cable collector

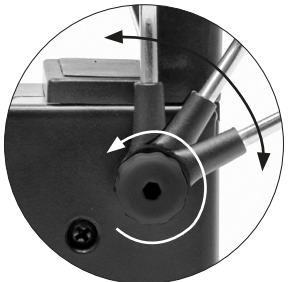

Tip Cleaner

Improve thermal transfer by cleaning the tip after each solder joint.

Brass wool

Ref. CL6210
Very effective cleaning method. It leaves a small layer of solder on the tip to prevent oxidation between cleaning and rewetting.

Sponge

Ref. S0354
The least harmful cleaning method. Keep the sponge damp with distilled water when working to avoid tip wear.

Splashguard

It prevents splashing of solder particles when using the brass wool.

Wiper

Ref. CL0236
A temperature resistant receptacle lets the operator remove excess solder by gentle tapping or wiping. It can be easily removed for cleaning.

Non-slip base

Heavy weighted non-slip base for simple-handed cleaning.

Tapping:

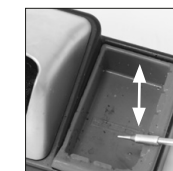

Tap gently to remove excess solder.

Wiping:

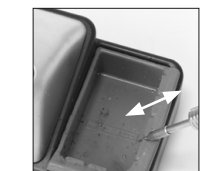

Use the slots to remove remaining particles.

Optional

Inox wool

Ref. CL6205



Brushes

Ref. CL6220



Tip-tinner

Ref. TT-A



Sand

Ref. CL6211



T245 Changing Cartridges

Save time and change cartridges safely without switching the station off.

1. Removing

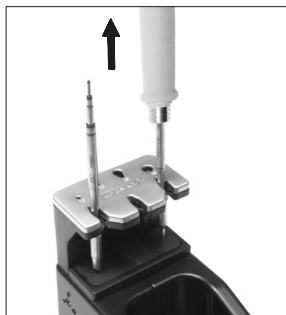

Place the handle in the extractor and pull to remove the cartridge.

2. Inserting

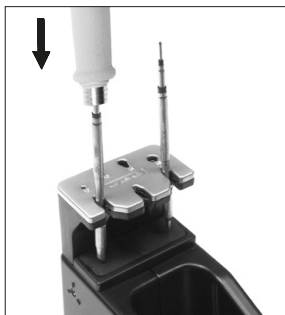

Place the handle on top of the new cartridge and press down slightly.

3. Fixing

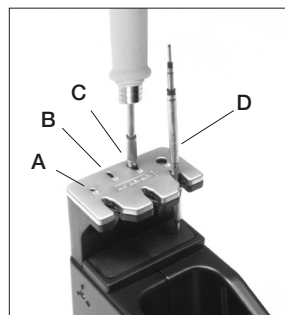

Use the holes for fixing the cartridge* as follows:

- A. For straight C210.
- B. For curved C210.
- C. For curved C245.
- D. For straight C245.

*Important

It is essential to insert the cartridges as far as the mark for a proper connection.

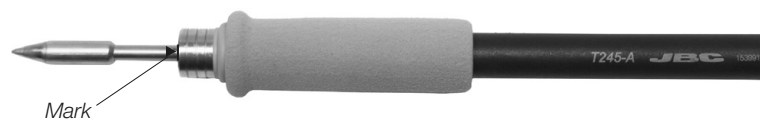

Compatible cartridges

The T245 handle works with C245 cartridges. Find the model that best suits your soldering needs in www.jbctools.com

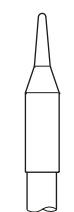

Round



Chisel



Round bent

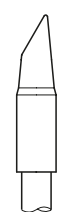

Bevel

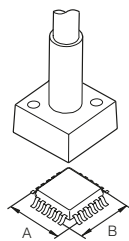

Special models

DR560 Changing Tips

This operation should be done while the tip is hot, not below 250°C, so that any tin left inside is in molten state.

1. Removing

Unscrew the tip using the spanner supplied.

2. Inserting

Fit the new tip and tighten with the spanner to make sure it is air tight.



Compatible Tips

The DR560 works with C560 tips. Find the model that best suits your soldering needs in www.jbctools.com
Here are some C560 tips in real size (mm):

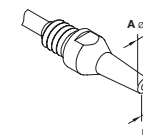

C560-001 ØA=1,4 ØB=0,6 Ømax. pin=0,4

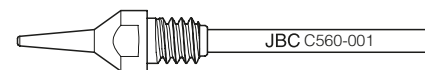

C560-002 ØA=1,8 ØB=0,8 Ømax. pin=0,6

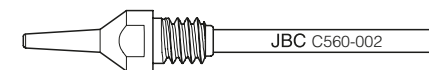

C560-014 ØA=2,5 ØB=0,8 Ømax. pin=0,6

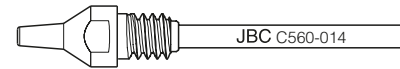

C560-003 ØA=2,7 ØB=1 Ømax. pin=0,8

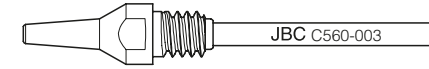

C560-004 ØA=3,2 ØB=1,3 Ømax. pin=1,1

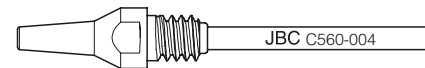

C560-009 ØA=5 ØB=1,3 Ømax. pin=1,1

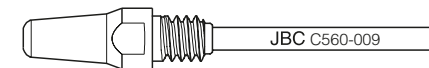

DR560 Changing the Heating Element

To perform this operation, turn off the station or disconnect the tool.

1. Loosening

The deposit lid needs to be loosened.



2. Removing

Loosen the screw as shown and remove the Heating Element.



3. Placing

Place the new Heating Element and follow the steps conversely.

Important

For a proper connection it is essential to insert the cartridge by lining it up to the mark ►.

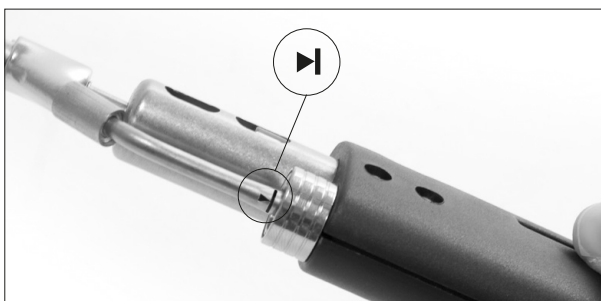

DR560 Tin Deposit Cleaning

1. Removing the lid

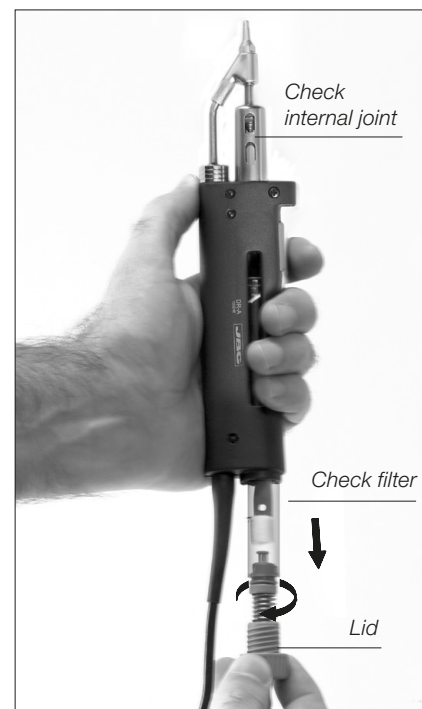

The lid must be removed with the DR560 in vertical position.

3. Inserting the deposit

The deposit must be inserted with coil filter in place, positioned between the 2 lines marked on the tin deposit.

Then the whole unit must be closed by screwing the lid.

2. Cleaning

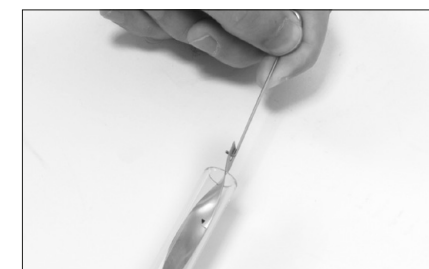

Remove the coil to clean the inside of the deposit with the stick supplied.



The filter and internal joint must be checked and replaced if dirty or damaged.



DR560 Tip Care

The intake tube should be periodically cleaned by the largest rod.



Important

DO NOT press the vacuum pump button while tinning the desoldering tip, as the fumes given off by the flux would quickly block the ducts and the air filter.

Desoldering process

Use a tip with a larger diameter than the pad to achieve maximum aspiration and thermal efficiency.

1. Placing

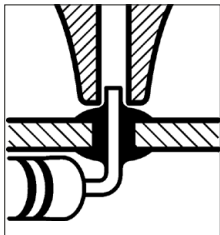

Place the tip with the component terminal in the hole.

2. Rotating

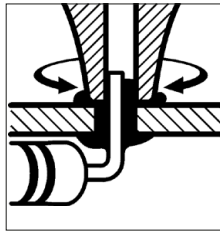

When the solder liquefies, gently rotate the tip so that the component terminal can be lifted off.

3. Aspirating

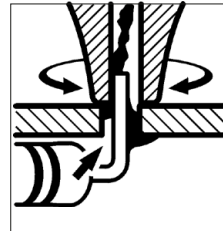

Press the vacuum pump button long enough to remove the solder.

After pressing the desoldering key there is a slight delay until the self-contained vacuum pump stops. This makes sure that the vacuum circuit is completely empty. If any solder remains are left on a terminal after desoldering it, resolder it with fresh solder and repeat the desoldering operation.

MVE Initial Setup

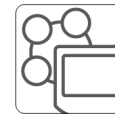

Peripherals

After connecting the pneumatic desoldering module (MVE-A), enter the **Peripherals** Menu and select the port which you want to join with the module.

1. Select the module from the list of peripheral connections. Remember your first connection is denoted as "a", the second being "b", etc. (e.g. MVE_a, MVE_b,...)

2. Press Menu or Back to save changes. Once set up, you can change the module settings by entering the **Peripherals** Menu.

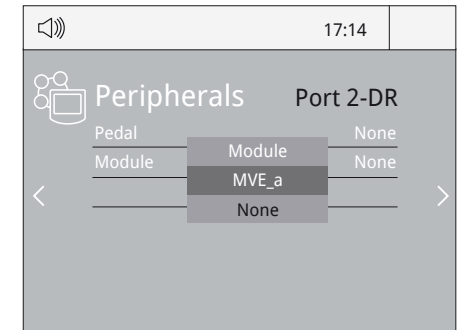

MVE Changing the pump filters

- Use a damp cloth to keep the casing clean.
- Periodically check all cable and tube connections.
- Keep filters clean to ensure proper solder suction and replace them when necessary.

Suction filter
Ref. 0821830

Cotton filters
Ref. 0781046

O Ring
Ref. 0007717

Filter cover
Ref. 0004710

Spare filters
Ref. 0005966

Release ring

Escape filter
Ref. 0008446

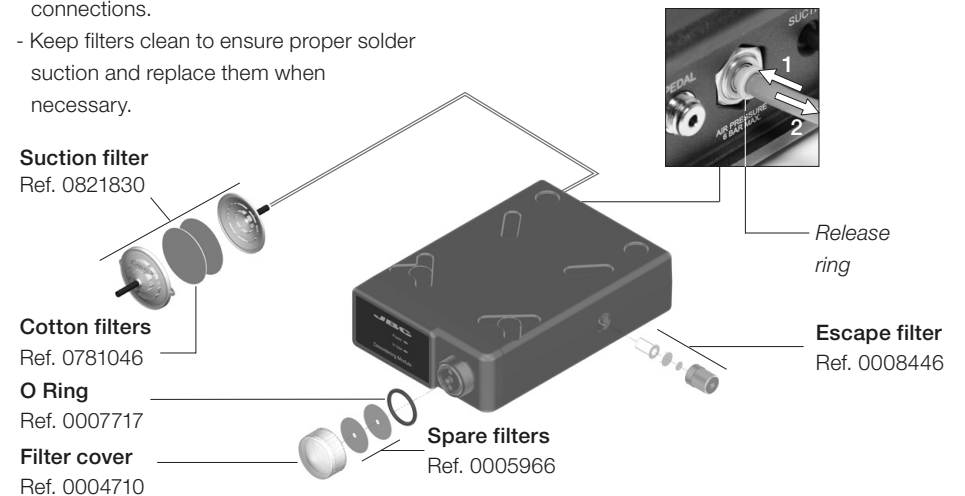

Important: Do not use sharp pointed objects to open the suction filter.

Removing the pneumatic tubing

- Push the release ring to remove the pneumatic tubing.

Operation

The JBC Exclusive Heating System

Our revolutionary technology is able to recover tip temperature extremely quickly. It means the user can work at a lower temperature and improve the quality of soldering. The tip temperature is further reduced thanks to the Sleep and Hibernation modes which increase the tip life by 5.

1. Work



When the tool is lifted from the stand the tip will heat up to the selected temperature.

2. Sleep



When the tool is in the stand, the temperature falls to the preset Sleep temperature.

3. Hibernation



After longer periods of inactivity, the power is cut off and the tool cools down to room temperature.

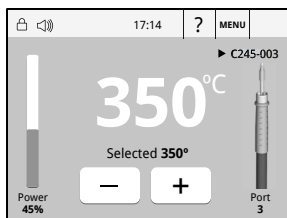

- Tools Menu:
- Adjust temperature and cartridge
 - Set temperature levels



- Tools Menu:
- Set Sleep temperature
 - Set Sleep delay (from 0 to 9 min or no Sleep)

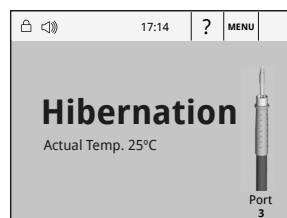

- Tools Menu:
- Set Hibernation delay (from 0 to 60 min or no hibernation)

Work Screen

The DME-A offers an intuitive user interface which provides quick access to the station parameters.

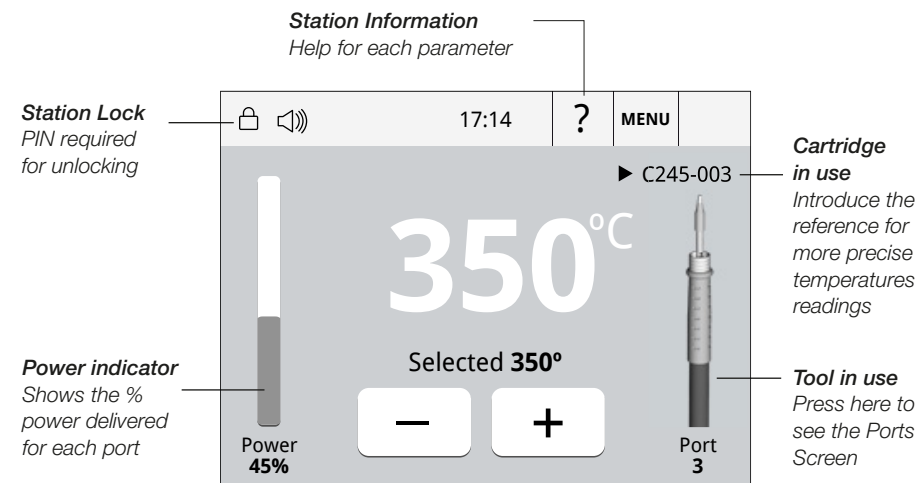

Simultaneous control of ports

See the information of all ports in real time when pressing the tool image from the Work screen.

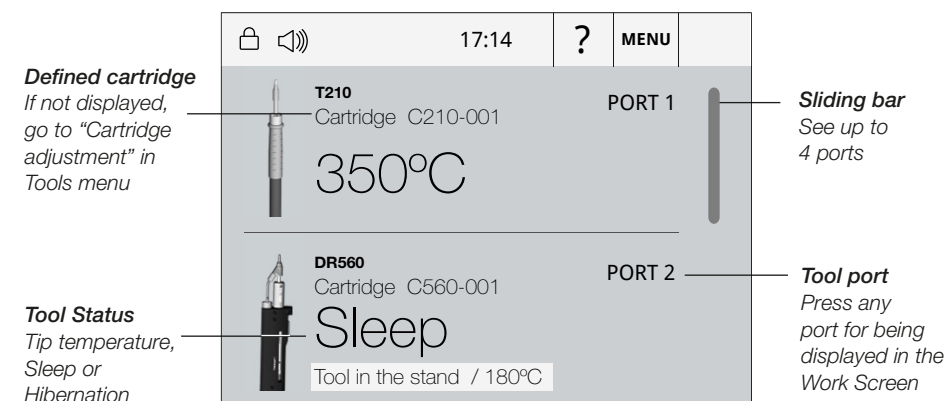

Menu Screen

Select any option and press the station information button to display each parameter description.

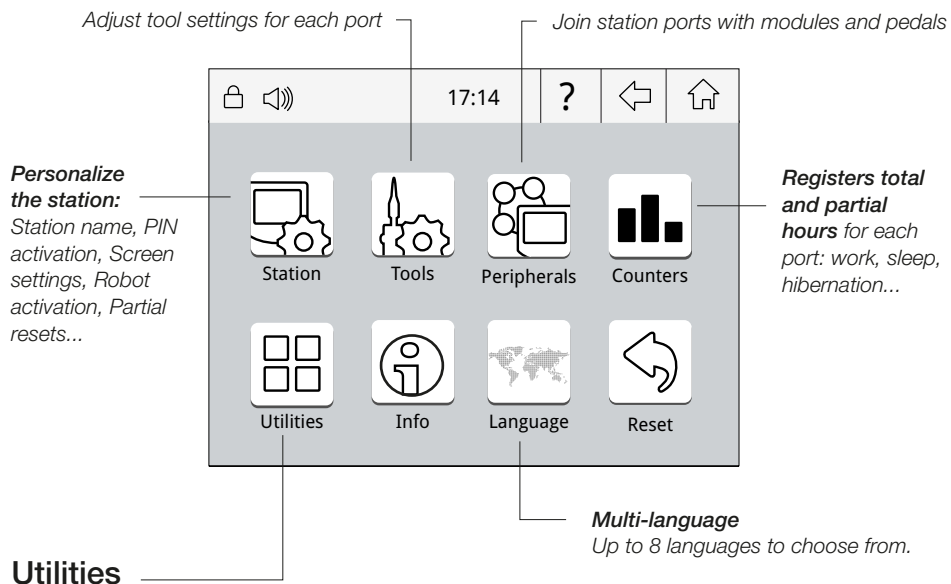

Useful additional applications that complement and support your work.

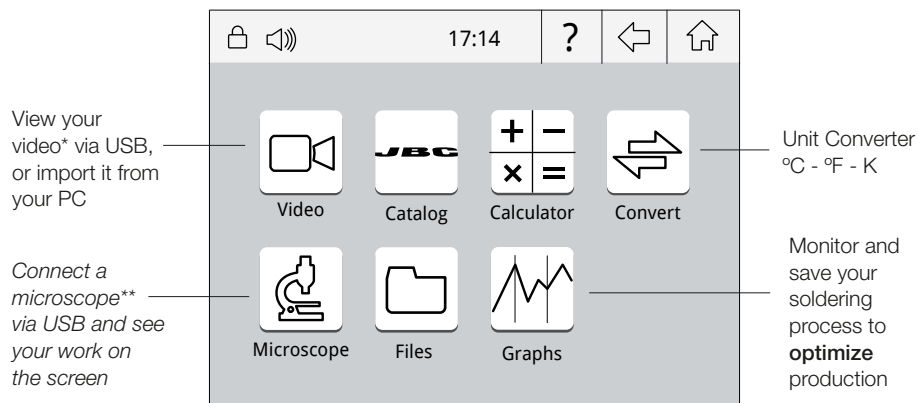

* Format file video: AVI and MP4 / Resolution: 320x240 / Aspect ratio: 16:9 / Frame rate: 18 FPS

**Recommended model: Dino-Lite AM2011 and equivalent.

Cartridge Adjustment

Insert the cartridge model and the station will recognize its characteristics (size and shape) to provide more accurate temperature readings.

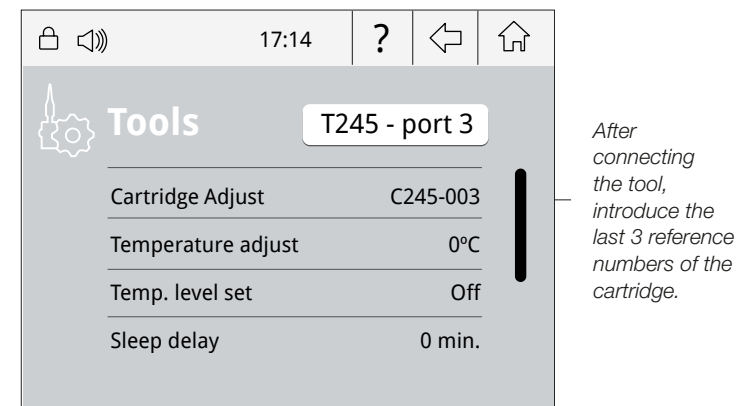

System notifications

The following icons may be displayed on the status bar on the screen.

- USB flash drive is connected to the USB-A.
- Warning. Press here for description.
- Station is controlled by a PC.
- Error. Press here for failure description, the type of error and how to proceed.
- Station is controlled by a robot.
- Indicates there is a peripheral to be installed.
- The station is being updated by a USB flash drive.

Process analysis

Optimize your production after analysing the information provided by the graphics.



Graphics

By pressing **Graphics** in the Utilities MENU, temperature and power figures in real time are displayed for each port. This helps you decide how to adjust your process or which tip to use to obtain the best quality soldering.

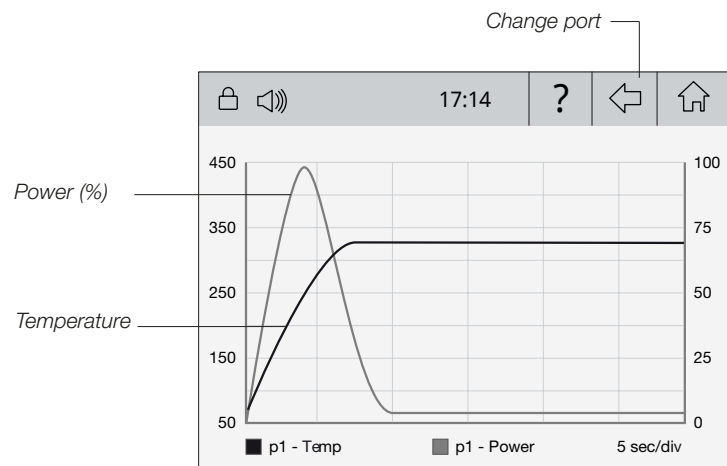

Export graphics

Insert a USB flash drive into the USB-A connector to save your soldering process in csv format.



Soldering Network

Remotely manage and monitor as many stations as your PC can handle.

1. Download the **JBC Manager software** and the user manual from www.jbctools.com/manager.html
2. Connect the stations via USB-B or LAN (RJ45) and the PC will automatically detect them.
3. The icon  will appear on the screen.

Functions:

- Set all the station parameters from your PC.
- Organize groups of stations and set all their parameters at the same time.
- Store specific configurations for later uses.
- Analyze the soldering graphics of the stations on your PC and export them.

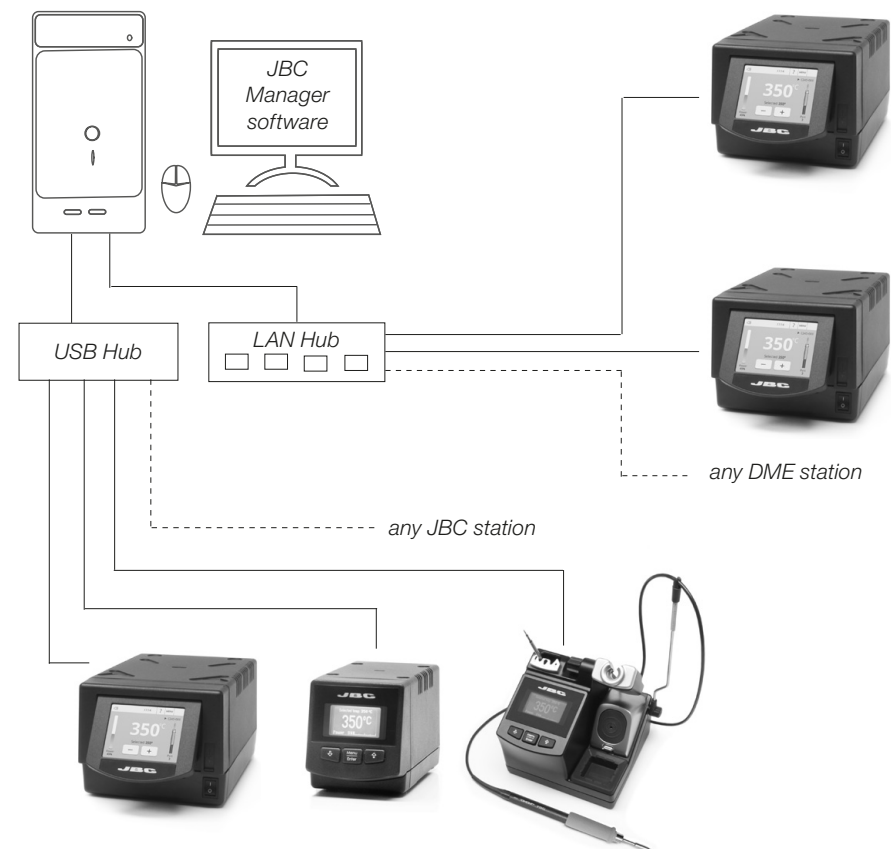

Increase x4 your DME's possibilities

Centralize control of 3 PSE Power Supply Units in a single DME and work with as many as 16 tools simultaneously.

1. Connect the DME to the **PSE Power Supply Units** via the PS connector (RJ12).
2. Connect the other PSE's as follows:

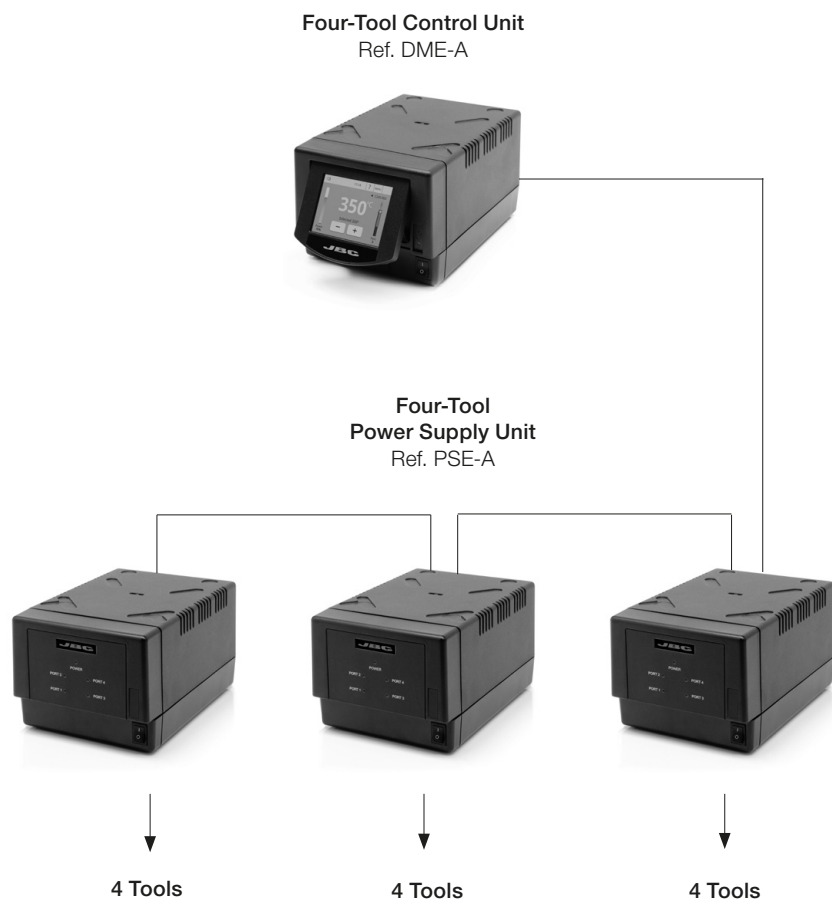

Working with Robots

Manage and monitor the station using a Robotic system.

1. Connect the tool to the station port by means of the CHB-A Converter.
2. Connect your Robot system to the station's Robot connector (RJ12).
DB9-RJ12 Adapter available on request (Ref: 0013772).
3. Enable the Robot option in the station settings and the icon will appear: 
4. Set your Robot's commands according to the Robot Communication Protocol, available on the website www.jbctools.com/jbcsoftware-menu-115.html.

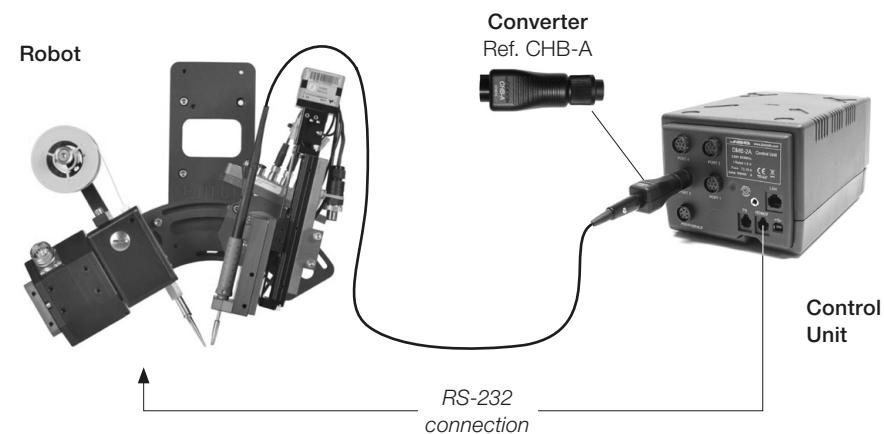

Update the station software

1. Download the update file when available at www.jbctools.com/software.html and save it on a USB flash drive. Preferably one with no other files.
2. Insert the USB flash drive.
The icon  is displayed while updating.

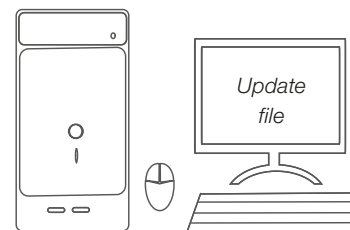

Maintenance

Before carrying out maintenance or storage, always allow the equipment to cool.

- Clean the station screen with a glass cleaner or a damp cloth.
- Use a damp cloth to clean the casing and the tool. Alcohol can only be used to clean the metal parts.
- Periodically check that the metal parts of the tool and stand are clean so that the station can detect the tool status.
- Maintain tip surface clean and tinned prior to storage in order to avoid tip oxidation. Rusty and dirty surfaces reduce heat transfer to the solder joint.
- Periodically check all cables and tubes.
- Replace a blown fuse as follows:

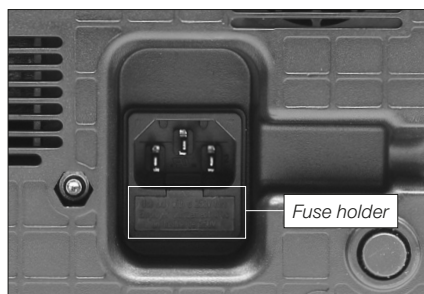

1. Pull off the fuse holder and remove the fuse. If necessary use a tool to lever it off.

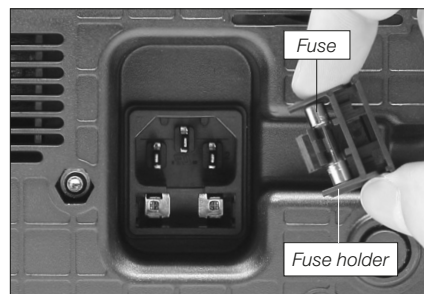

2. Press the new fuse into the fuse holder and replace it in the station.

- Replace any defective or damaged pieces. Use original JBC spare parts only.
- Repairs should only be performed by a JBC authorized technical service.

Safety



It is imperative to follow safety guidelines to prevent electric shock, injury, fire or explosion.

- Do not use the units for any purpose other than soldering or rework. Incorrect use may cause fire.
- The power cord must be plugged into approved bases. Be sure that it is properly grounded before use. When unplugging it, hold the plug, not the wire.
- Do not work on electrically live parts.
- The tool should be placed in the stand when not in use in order to activate the sleep mode. The soldering tip, the metal part of the tool and the stand may still be hot even when the station is turned off. Handle with care, including when adjusting the stand position.
- Do not leave the appliance unattended when it is on.
- Do not cover the ventilation grills. Heat can cause inflammable products to ignite.
- Use a "non residue" classified flux and avoid contact with skin or eyes to prevent irritation.
- Be careful with the fumes produced when soldering.
- Keep your workplace clean and tidy. Wear appropriate protective glasses and gloves when working to avoid personal harm.
- Utmost care must be taken with liquid tin waste which can cause burns.
- This appliance can be used by children over the age of eight and also persons with reduced physical, sensory or mental capabilities or lack of experience provided that they have been given adequate supervision or instruction concerning use of the appliance and understand the hazards involved. Children must not play with the appliance.
- Maintenance must not be carried out by children unless supervised.

Specifications

4 Tools Rework station with Pneumatic Pump

DMVE-1A / DMVE-2A / DMVE-9A

- Total weight: 10.1 Kg (22.3 lb)

DME-1A 120V 50/60Hz. Input fuse: 6A. Output: 23.5V

DME-2A 230V 50/60Hz. Input fuse: 3.15A. Output: 23.5V

DME-9A 100V 50/60Hz. Input fuse: 8A. Output: 23.5V

- Weight: 4.6 Kg (10 lb)
- Dimensions: 148 x 120 x 232 mm
- Output Peak Power: 160W per tool
- Temperature Range: 90-450°C (190-840°F)
- Idle Temp. Stability (still air): ±1.5 °C (±3 °F)
- Ambient Operating Temperature: 10-40 °C (50-104 °F)
- Tip to ground resistance: <2 ohms
- Tip to ground voltage: <2mV RMS
- USB-A / USB-B / Peripherals connectors
- RJ12 connectors: 1 for Robot and 1 for PSE Power Supply Control Unit.
- RJ45 connector for LAN (Ethernet).

MVE-A

- Weight: 0.7 Kg (1.54 lb)
- Dimensions: 145 x 55 x 225 mm
- Air Pressure supply range: 4-6 Bar
- Vacuum at 6 Bar: 90% / 680 mmHg / 26.8 inHg
- Flow rate: 15 SLPM

Complies with CE standards

ESD protected housing "skin effect"

Exploded View · Despiece · Explosionszeichnung

DMSE-1A 120V
DMSE-2A 230V
DMSE-9A 100V
4 TOOLS REWORK STATION
WITH ELECTRIC PUMP

DME-1A / DME-2A / DME-9A

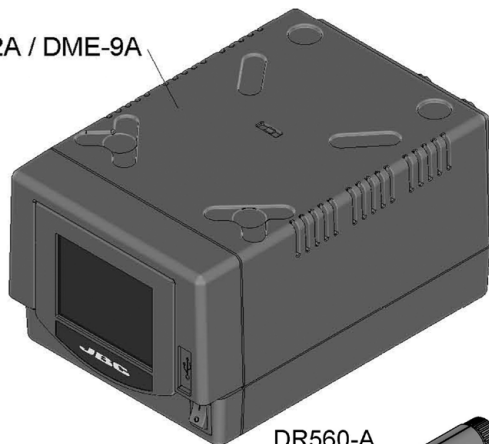

SPARE PARTS	
DME-1A / DME-2A / DME-9A:	
-CIRCUIT	0017456
-ENCLOSURE	
· TOP	0011035
· BOTTOM	0014567
· FRONT+DISPLAY	0011014
· BACK	0011861
MSE-A:	
-CIRCUIT	0017464
-ENCLOSURE	
· TOP	0015266
· BOTTOM	0014010
· FRONT	0014688
· BACK	0015261
-PUMP	0005652

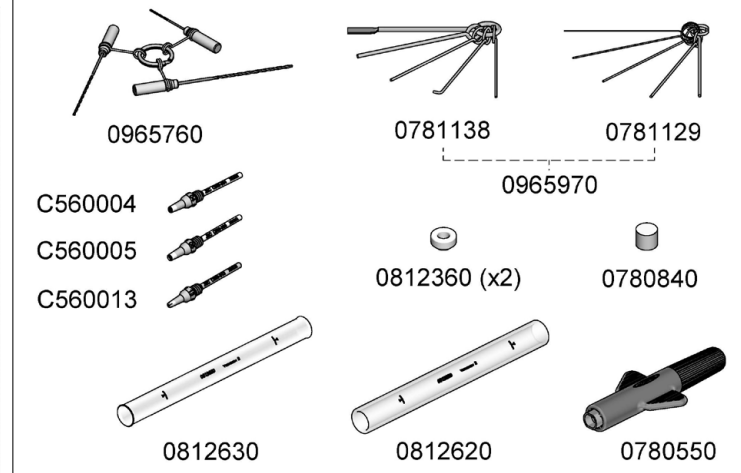

DMSE-1A 120V FUSE T-6A
DMSE-2A 230V FUSE T-3,15A
DMSE-9A 100V FUSE T-8A

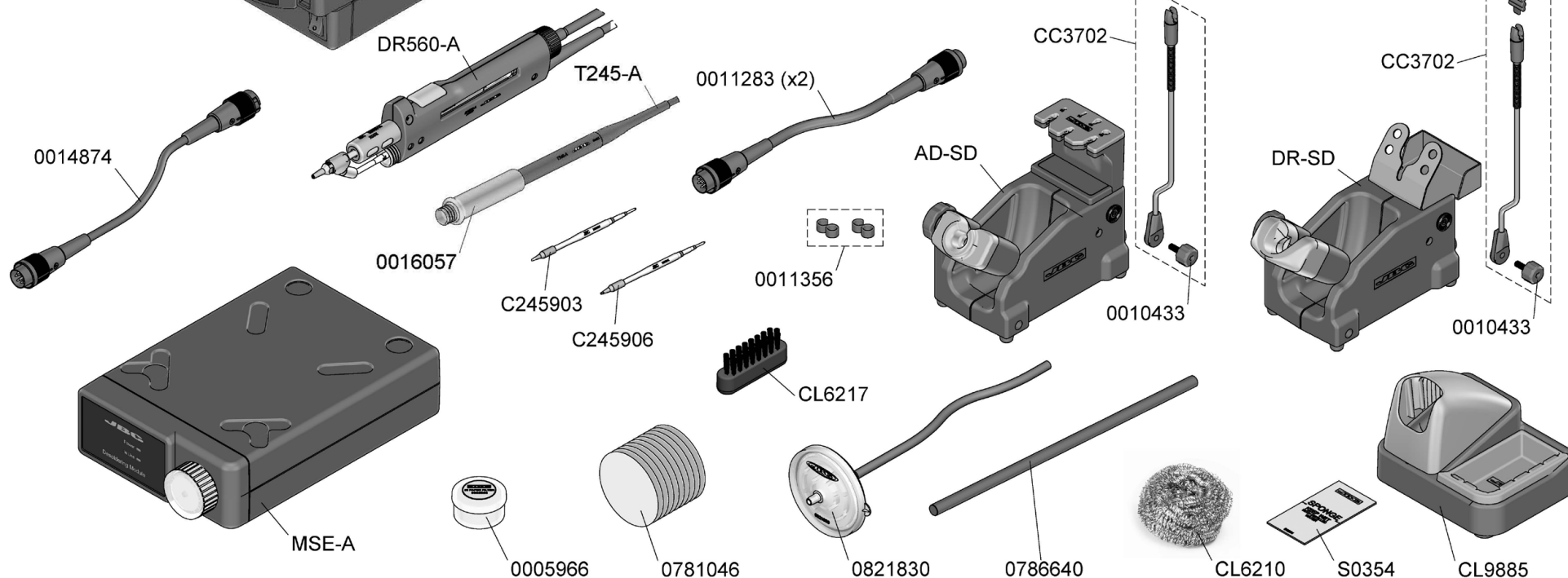

JBC

Warranty

JBC's 2 year warranty covers this equipment against all manufacturing defects, including the replacement of defective parts and labour. Warranty does not cover product wear due to use or mis-use.

In order for the warranty to be valid, equipment must be returned, postage paid, to the dealer where it was purchased.



This product should not be thrown in the garbage. In accordance with the European directive 2012/19/EU, electronic equipment at the end of their life must be collected and returned to an authorized recycling facility.