

FAN3100

Single 2A High-Speed, Low-Side Gate Driver

Features

- 3A Peak Sink/Source at $V_{DD} = 12V$
- 4.5 to 18V Operating Range
- 2.5A Sink / 1.8A Source at $V_{OUT} = 6V$
- Dual-Logic Inputs Allow Configuration as Non-Inverting or Inverting with Enable Function
- Internal Resistors Turn Driver Off If No Inputs
- 13ns Typical Rise Time and 9ns Typical Fall-Time with 1nF Load
- Choice of TTL or CMOS Input Thresholds
- MillerDrive™ Technology
- Typical Propagation Delay Time Under 20ns with Input Falling or Rising
- 6-Lead 2x2mm MLP or 5-Pin SOT23 Packages
- Rated from $-40^{\circ}C$ to $125^{\circ}C$ Ambient

Applications

- Switch-Mode Power Supplies
- High-Efficiency MOSFET Switching
- Synchronous Rectifier Circuits
- DC-to-DC Converters
- Motor Control

Description

The FAN3100 2A gate driver is designed to drive an N-channel enhancement-mode MOSFET in low-side switching applications by providing high peak current pulses during the short switching intervals. The driver is available with either TTL (FAN3100T) or CMOS (FAN3100C) input thresholds. Internal circuitry provides an under-voltage lockout function by holding the output low until the supply voltage is within the operating range. The FAN3100 delivers fast MOSFET switching performance, which helps maximize efficiency in high-frequency power converter designs.

FAN3100 drivers incorporate MillerDrive™ architecture for the final output stage. This bipolar-MOSFET combination provides high peak current during the Miller plateau stage of the MOSFET turn-on / turn-off process to minimize switching loss, while providing rail-to-rail voltage swing and reverse current capability.

The FAN3100 also offers dual inputs that can be configured to operate in non-inverting or inverting mode and allow implementation of an enable function. If one or both inputs are left unconnected, internal resistors bias the inputs such that the output is pulled low to hold the power MOSFET off.

The FAN3100 is available in a lead-free finish 2x2mm 6-lead Molded Leadless Package (MLP), for smallest size with excellent thermal performance, or industry-standard 5-pin SOT23.

Functional Pin Configurations

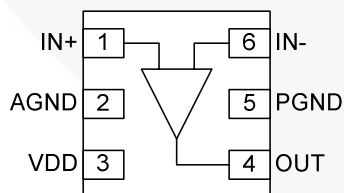

Figure 1. 2x2mm 6-Lead MLP (Top View)

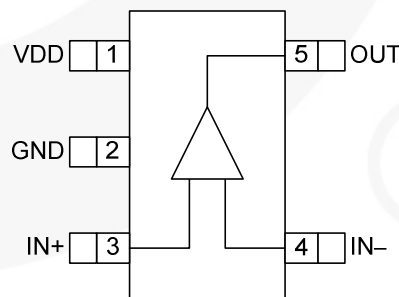



Figure 2. SOT23-5 (Top View)

Ordering Information

Part Number	Input Threshold	 Eco Status	Package	Packing Method	Quantity / Reel
FAN3100CMPX	CMOS	Green	6-Lead 2x2mm MLP	Tape & Reel	3000
FAN3100CSX	CMOS	RoHS	5-Pin SOT23	Tape & Reel	3000
FAN3100TMPX	TTL	Green	6-Lead 2x2mm MLP	Tape & Reel	3000
FAN3100TSX	TTL	RoHS	5-Pin SOT23	Tape & Reel	3000

 For Fairchild's definition of "green" Eco Status, please visit: http://www.fairchildsemi.com/company/green/rohs_green.html.

Package Outlines

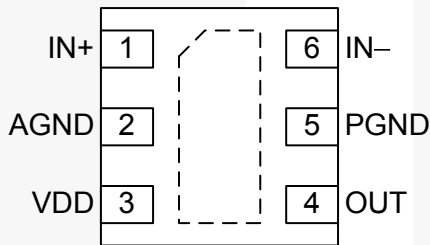

Figure 3. 2x2mm 6-Lead MLP (Top View)

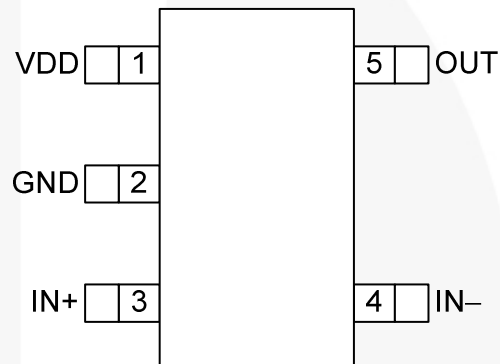

Figure 4. SOT23-5 (Top View)

Thermal Characteristics⁽¹⁾

Package	Θ_{JL} ⁽²⁾	Θ_{JT} ⁽³⁾	Θ_{JA} ⁽⁴⁾	Ψ_{JB} ⁽⁵⁾	Ψ_{JT} ⁽⁶⁾	Units
6-Lead 2x2mm Molded Leadless Package (MLP)	2.7	133	58	2.8	42	°C/W
SOT23-5	56	99	157	51	5	°C/W

Notes:

- Estimates derived from thermal simulation; actual values depend on the application.
- Θ_{JL} (Θ_{JL}): Thermal resistance between the semiconductor junction and the bottom surface of all the leads (including any thermal pad) that are typically soldered to a PCB.
- Θ_{JT} (Θ_{JT}): Thermal resistance between the semiconductor junction and the top surface of the package, assuming it is held at a uniform temperature by a top-side heatsink.
- Θ_{JA} (Θ_{JA}): Thermal resistance between junction and ambient, dependent on the PCB design, heat sinking, and airflow. The value given is for natural convection with no heatsink, as specified in JEDEC standards JESD51-2, JESD51-5, and JESD51-7, as appropriate.
- Ψ_{JB} (Ψ_{JB}): Thermal characterization parameter providing correlation between semiconductor junction temperature and an application circuit board reference point for the thermal environment defined in Note 4. For the MLP-6 package, the board reference is defined as the PCB copper connected to the thermal pad and protruding from either end of the package. For the SOT23-5 package, the board reference is defined as the PCB copper adjacent to pin 2.
- Ψ_{JT} (Ψ_{JT}): Thermal characterization parameter providing correlation between the semiconductor junction temperature and the center of the top of the package for the thermal environment defined in Note 4.

Pin Definitions

SOT23 Pin #	MLP Pin #	Name	Pin Description
1	3	VDD	Supply Voltage. Provides power to the IC.
	2	AGND	Analog ground for input signals (MLP only). Connect to PGND underneath the IC.
2		GND	Ground (SOT-23 only). Common ground reference for input and output circuits.
3	1	IN+	Non-Inverting Input. Connect to VDD to enable output.
4	6	IN-	Inverting Input. Connect to AGND or PGND to enable output.
5	4	OUT	Gate Drive Output: Held low unless required inputs are present and V_{DD} is above UVLO threshold.
	Pad	P1	Thermal Pad (MLP only). Exposed metal on the bottom of the package which is electrically connected to pin 5.
	5	PGND	Power Ground (MLP only). For output drive circuit; separates switching noise from inputs.

Output Logic

IN+	IN-	OUT
0 ⁽⁷⁾	0	0
0 ⁽⁷⁾	1 ⁽⁷⁾	0
1	0	1
1	1 ⁽⁷⁾	0

Note:

7. Default input signal if no external connection is made.

Block Diagrams

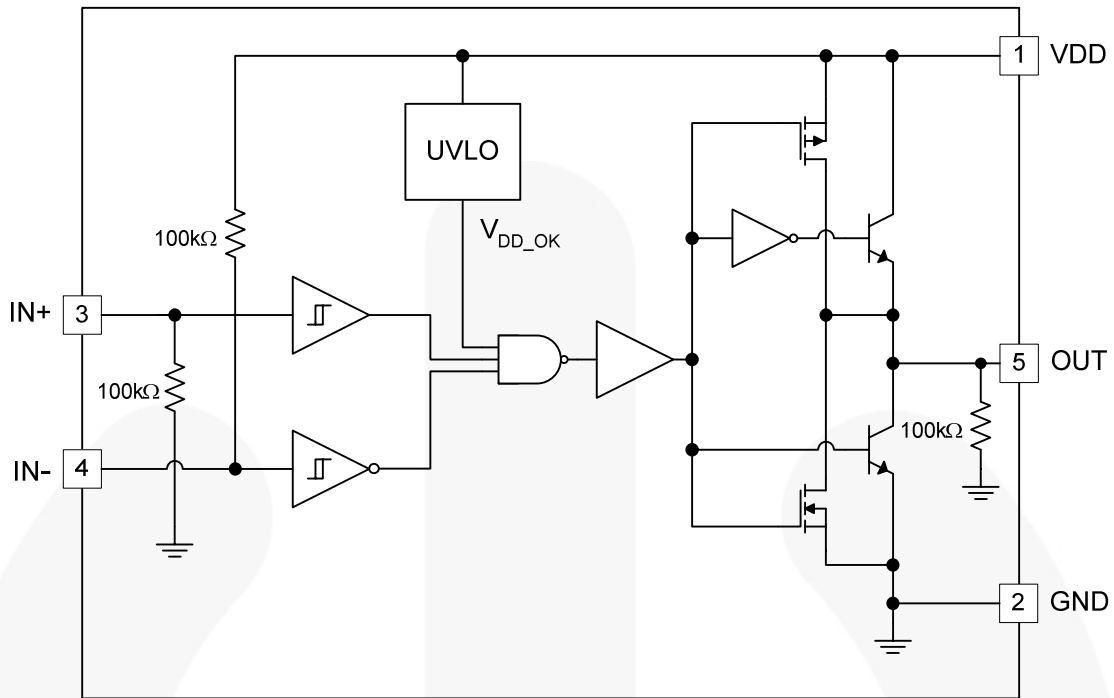

Figure 5. Simplified Block Diagram (SOT23 Pin-out)

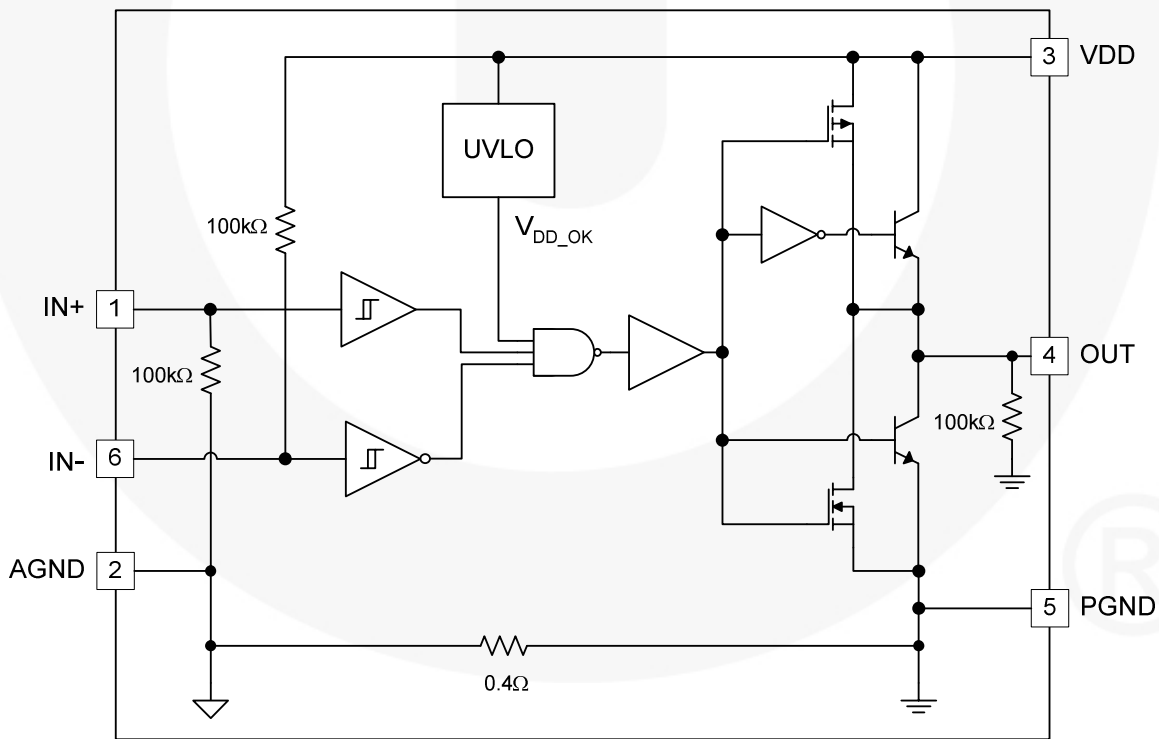

Figure 6. Simplified Block Diagram (MLP Pin-out)

Absolute Maximum Ratings

Stresses exceeding the absolute maximum ratings may damage the device. The device may not function or be operable above the recommended operating conditions and stressing the parts to these levels is not recommended. In addition, extended exposure to stresses above the recommended operating conditions may affect device reliability. The absolute maximum ratings are stress ratings only.

Symbol	Parameter		Min.	Max.	Unit
V _{DD}	VDD to PGND		-0.3	20.0	V
V _{IN}	Voltage on IN+ and IN- to GND, AGND, or PGND		GND - 0.3	V _{DD} + 0.3	V
V _{OUT}	Voltage on OUT to GND, AGND, or PGND		GND - 0.3	V _{DD} + 0.3	V
T _L	Lead Soldering Temperature (10 seconds)			+260	°C
T _J	Junction Temperature		-55	+150	°C
T _{STG}	Storage Temperature		-65	+150	°C
ESD	Electrostatic Discharge Protection Level	Human Body Model, JEDEC JESD22-A114	4		kV
		Charged Device Model, JEDEC JESD22-C101	750		V

Recommended Operating Conditions

The Recommended Operating Conditions table defines the conditions for actual device operation. Recommended operating conditions are specified to ensure optimal performance to the datasheet specifications. Fairchild does not recommend exceeding them or designing to Absolute Maximum Ratings.

Symbol	Parameter		Min.	Max.	Unit
V _{DD}	Supply Voltage Range		4.5	18.0	V
V _{IN}	Input Voltage IN+, IN-		0	V _{DD}	V
T _A	Operating Ambient Temperature		-40	+125	°C

Electrical Characteristics

Unless otherwise noted, $V_{DD} = 12V$, $T_J = -40^{\circ}C$ to $+125^{\circ}C$. Currents are defined as positive into the device and negative out of the device.

Symbol	Parameter	Conditions	Min.	Typ.	Max.	Unit
Supply						
V_{DD}	Operating Range		4.5		18.0	V
I_{DD}	Supply Current Inputs/EN Not Connected	FAN3100C ⁽⁸⁾		0.20	0.35	mA
		FAN3100T		0.5	0.8	mA
V_{ON}	Turn-On Voltage		3.5	3.9	4.3	V
V_{OFF}	Turn-Off Voltage		3.3	3.7	4.1	V
Inputs (FAN3100T)						
V_{INL_T}	IN+, IN- Logic Low Voltage, Maximum		0.8			V
V_{INH_T}	IN+, IN- Logic High Voltage, Minimum				2.0	V
I_{IN+}	Non-inverting Input	IN from 0 to V_{DD}	-1		175	μA
I_{IN-}	Inverting Input	IN from 0 to V_{DD}	-175		1	μA
V_{HYS}	IN+, IN- Logic Hysteresis Voltage		0.2	0.4	0.8	V
Inputs (FAN3100C)						
V_{INL_C}	IN+, IN- Logic Low Voltage		30			% V_{DD}
V_{INH_C}	IN+, IN- Logic High Voltage				70	% V_{DD}
I_{INL}	IN Current, Low	IN from 0 to V_{DD}	-1		175	μA
I_{INH}	IN Current, High	IN from 0 to V_{DD}	-175		1	μA
V_{HYS_C}	IN+, IN- Logic Hysteresis Voltage			17		% V_{DD}
Output						
I_{SINK}	OUT Current, Mid-Voltage, Sinking ⁽⁹⁾	OUT at $V_{DD}/2$, $C_{LOAD} = 0.1\mu F$, $f = 1kHz$		2.5		A
I_{SOURCE}	OUT Current, Mid-Voltage, Sourcing ⁽⁹⁾	OUT at $V_{DD}/2$, $C_{LOAD} = 0.1\mu F$, $f = 1kHz$		-1.8		A
I_{PK_SINK}	OUT Current, Peak, Sinking ⁽⁹⁾	$C_{LOAD} = 0.1\mu F$, $f = 1kHz$		3		A
I_{PK_SOURCE}	OUT Current, Peak, Sourcing ⁽⁹⁾	$C_{LOAD} = 0.1\mu F$, $f = 1kHz$		-3		A
t_{RISE}	Output Rise Time ⁽¹⁰⁾	$C_{LOAD} = 1000pF$		13	20	ns
t_{FALL}	Output Fall Time ⁽¹⁰⁾	$C_{LOAD} = 1000pF$		9	14	ns
t_{D1}, t_{D2}	Output Prop. Delay, CMOS Inputs ⁽¹⁰⁾	0 - $12V_{IN}$; 1V/ns Slew Rate	7	15	28	ns
t_{D1}, t_{D2}	Output Prop. Delay, TTL Inputs ⁽¹⁰⁾	0 - $5V_{IN}$; 1V/ns Slew Rate	9	16	30	ns
I_{RVS}	Output Reverse Current Withstand ⁽⁹⁾			500		mA

Note:

8. Lower supply current due to inactive TTL circuitry.
9. Not tested in production.
10. See Timing Diagrams of Figure 7 and Figure 8.

Timing Diagrams

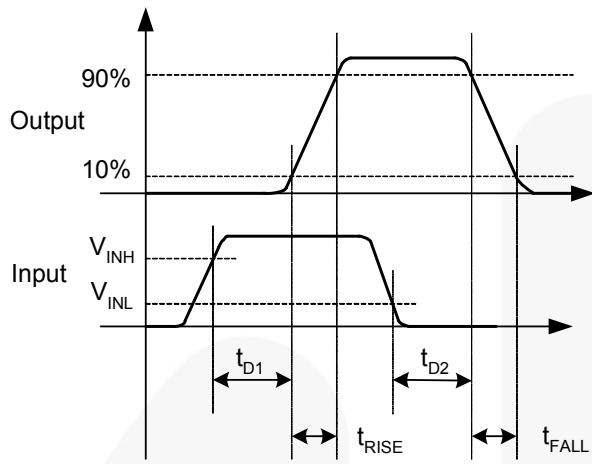

Figure 7. Non-Inverting

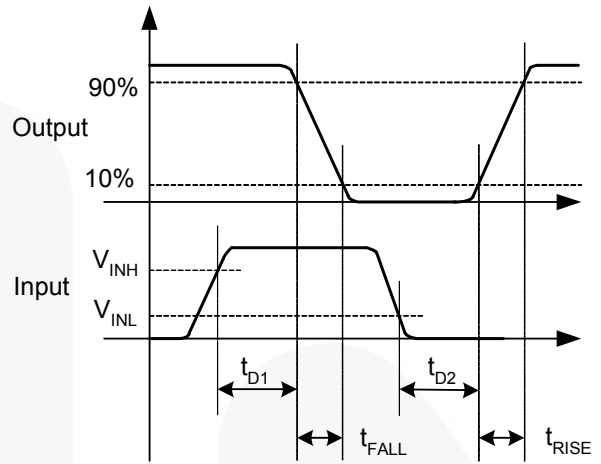

Figure 8. Inverting

Typical Performance Characteristics

Typical characteristics are provided at 25°C and $V_{DD}=12V$ unless otherwise noted.

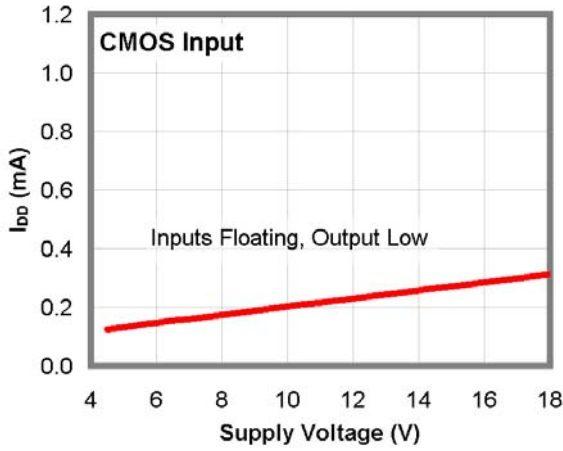

Figure 9. I_{DD} (Static) vs. Supply Voltage

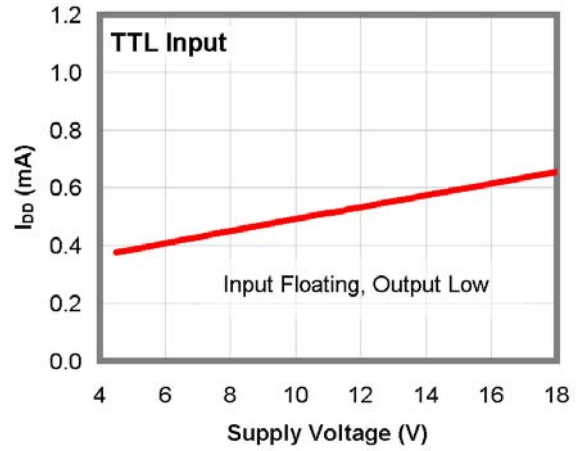

Figure 10. I_{DD} (Static) vs. Supply Voltage

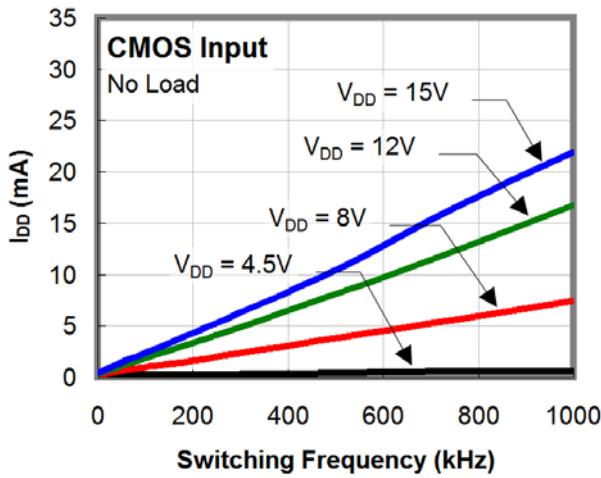

Figure 11. I_{DD} (No-Load) vs. Frequency

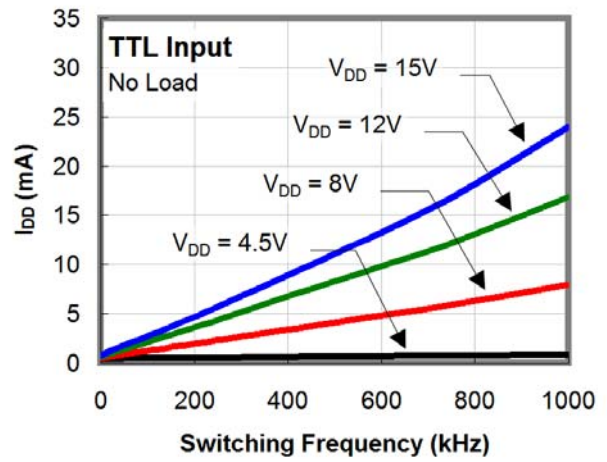

Figure 12. I_{DD} (No-Load) vs. Frequency

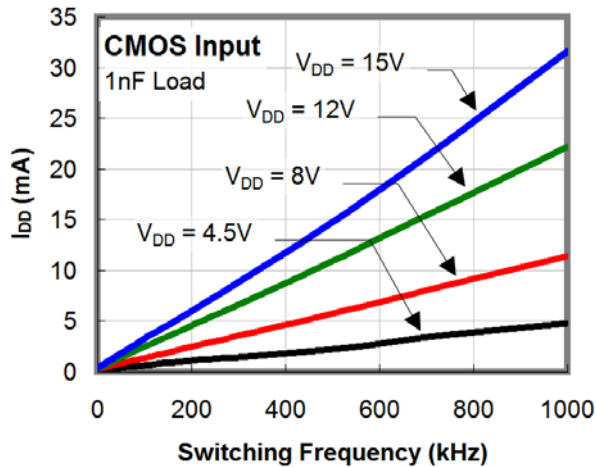

Figure 13. I_{DD} (1nF Load) vs. Frequency

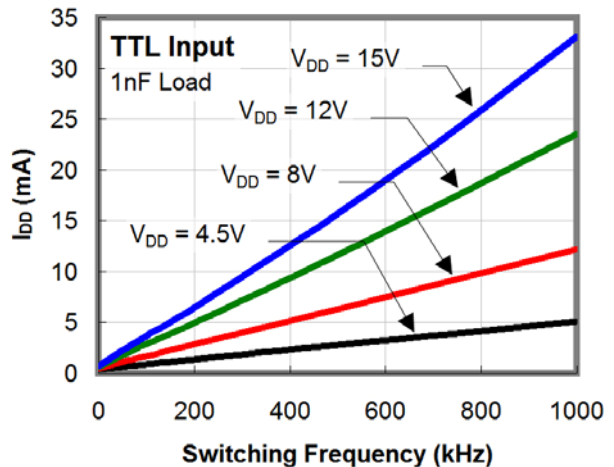

Figure 14. I_{DD} (1nF Load) vs. Frequency

Typical Performance Characteristics

Typical characteristics are provided at 25°C and $V_{DD}=12V$ unless otherwise noted.

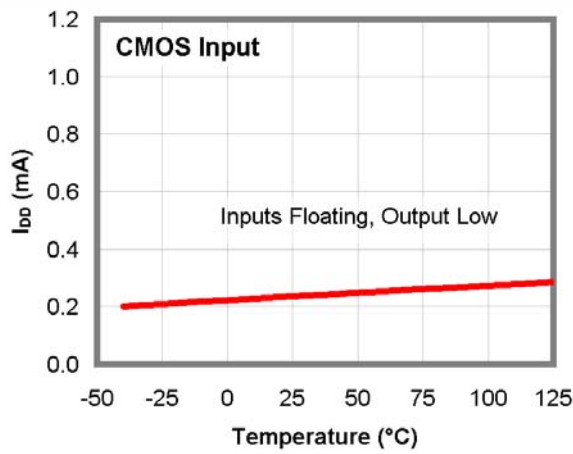

Figure 15. I_{DD} (Static) vs. Temperature

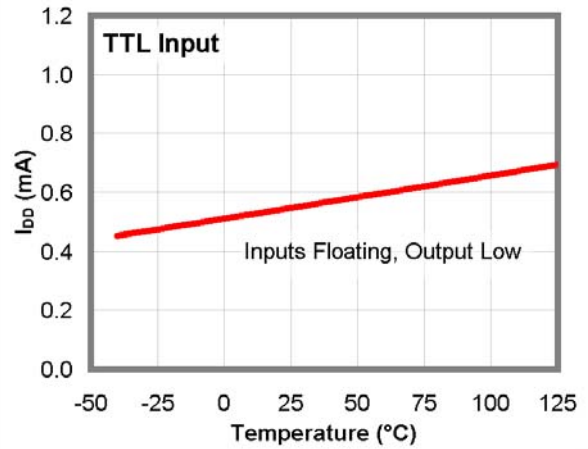

Figure 16. I_{DD} (Static) vs. Temperature

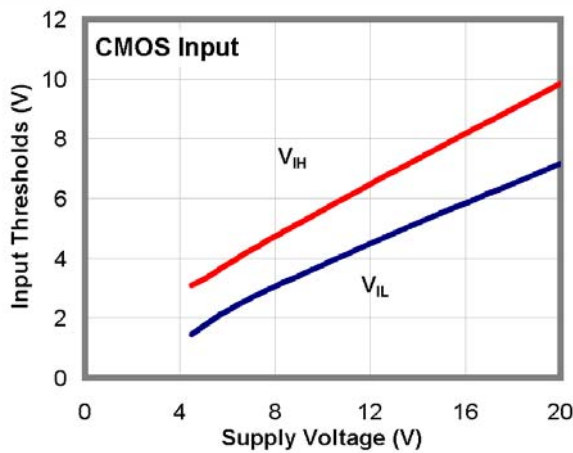

Figure 17. Input Thresholds vs. Supply Voltage

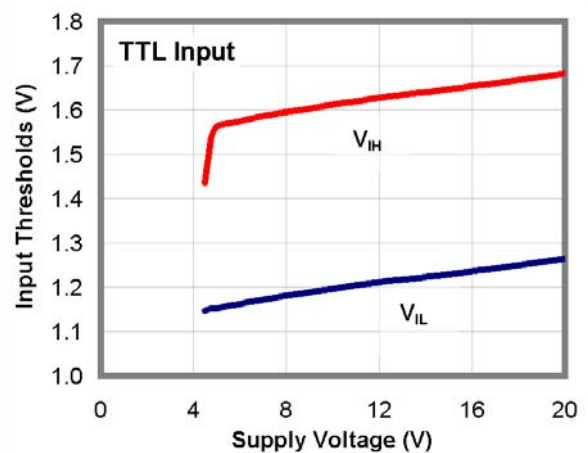

Figure 18. Input Thresholds vs. Supply Voltage

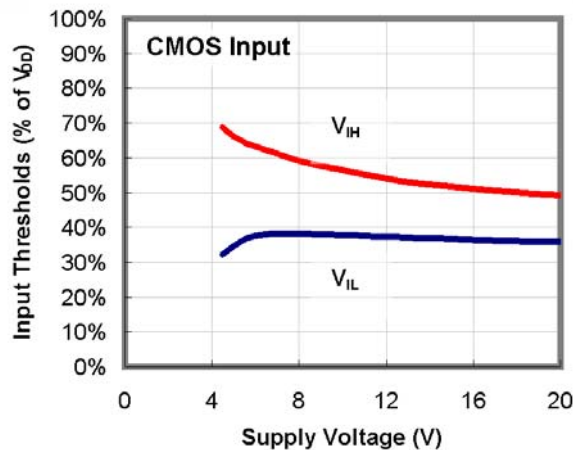

Figure 19. Input Thresholds % vs. Supply Voltage

Typical Performance Characteristics

Typical characteristics are provided at 25°C and $V_{DD}=12V$ unless otherwise noted.

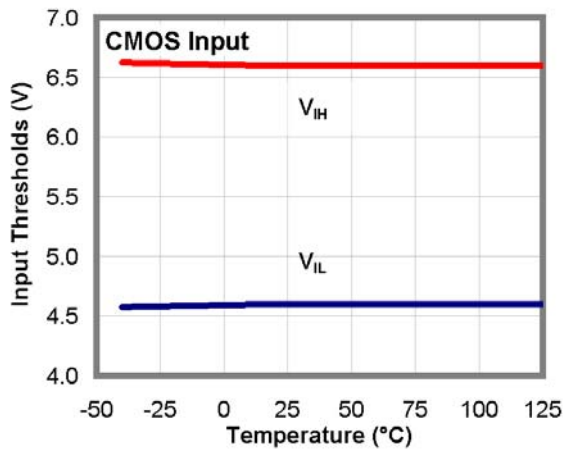

Figure 20. CMOS Input Thresholds vs. Temperature

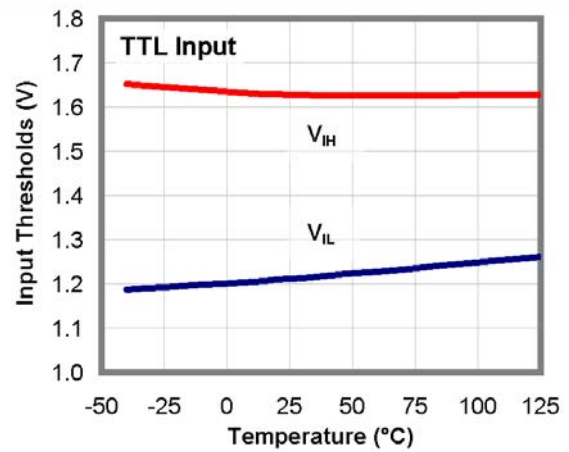

Figure 21. TTL Input Thresholds vs. Temperature

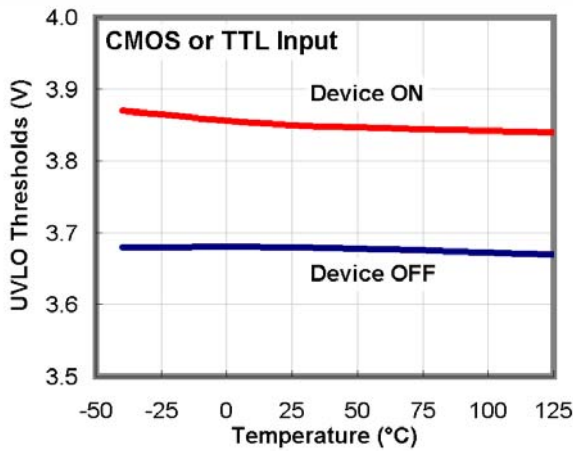

Figure 22. UVLO Thresholds vs. Temperature

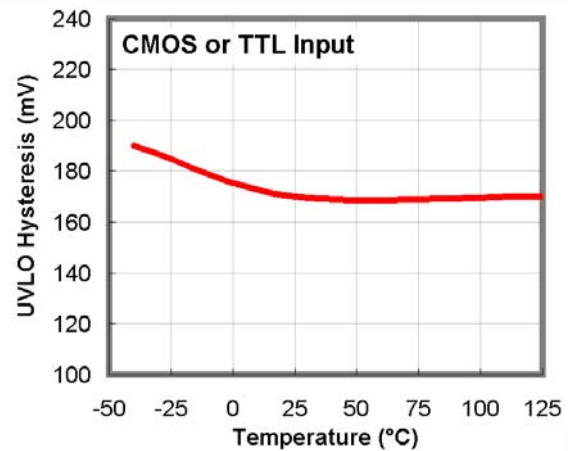

Figure 23. UVLO Hysteresis vs. Temperature

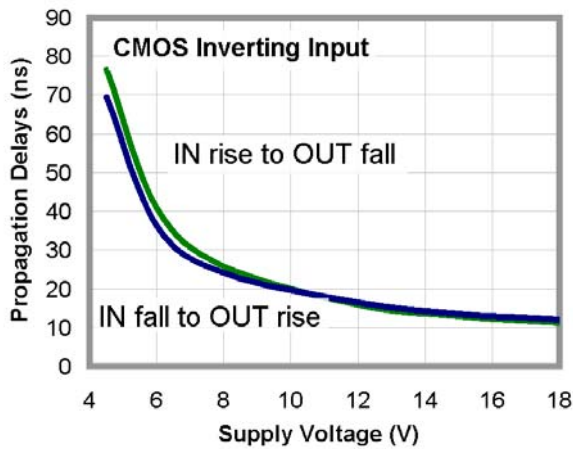

Figure 24. Propagation Delay vs. Supply Voltage

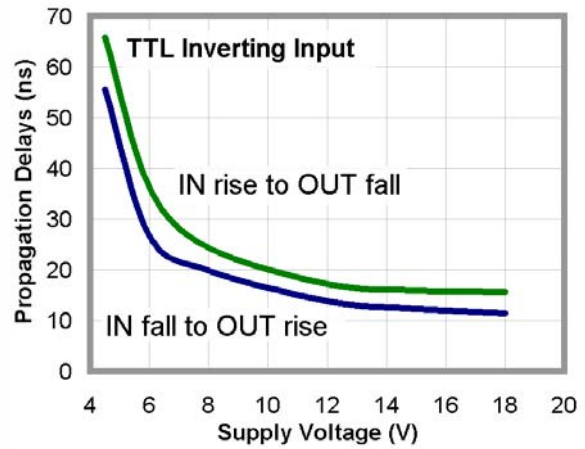

Figure 25. Propagation Delay vs. Supply Voltage

Typical Performance Characteristics

Typical characteristics are provided at 25°C and $V_{DD}=12V$ unless otherwise noted.

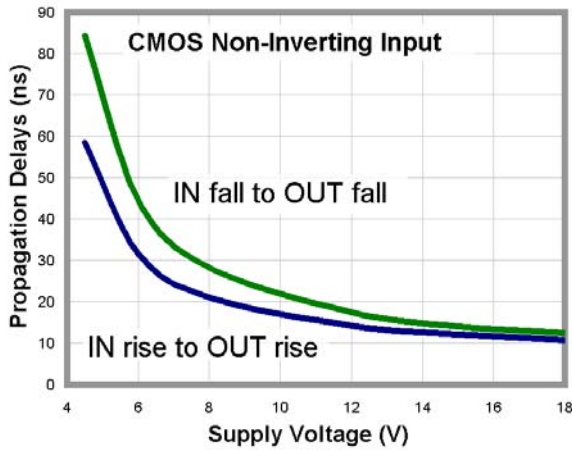

Figure 26. Propagation Delay vs. Supply Voltage

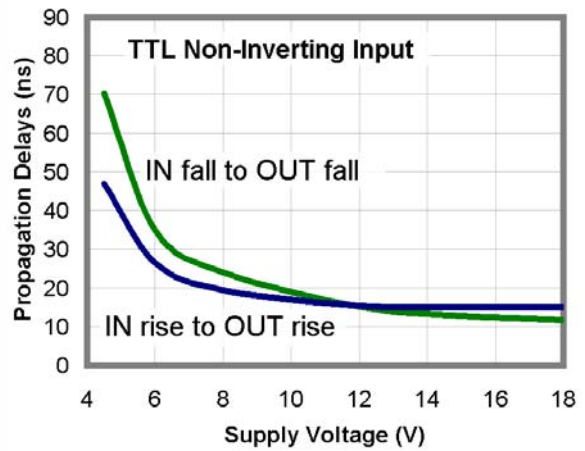

Figure 27. Propagation Delay vs. Supply Voltage

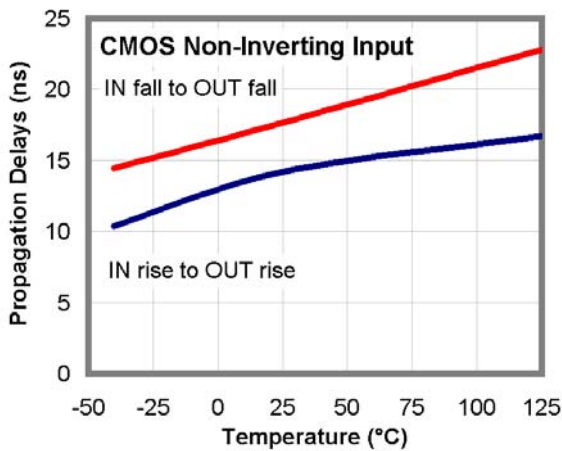

Figure 28. Propagation Delay vs. Temperature

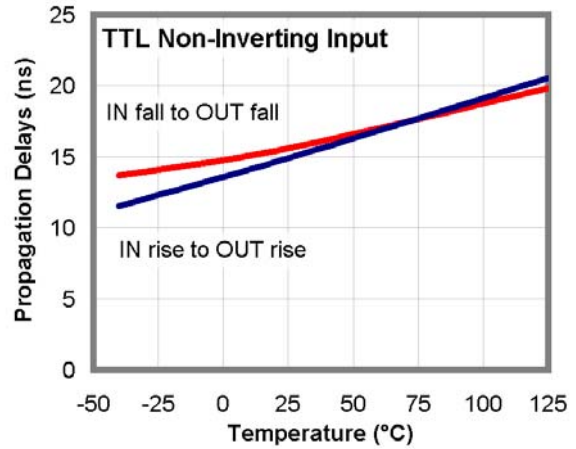

Figure 29. Propagation Delay vs. Temperature

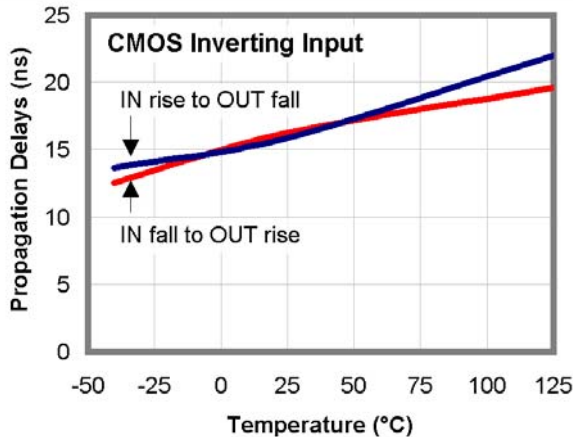

Figure 30. Propagation Delay vs. Temperature

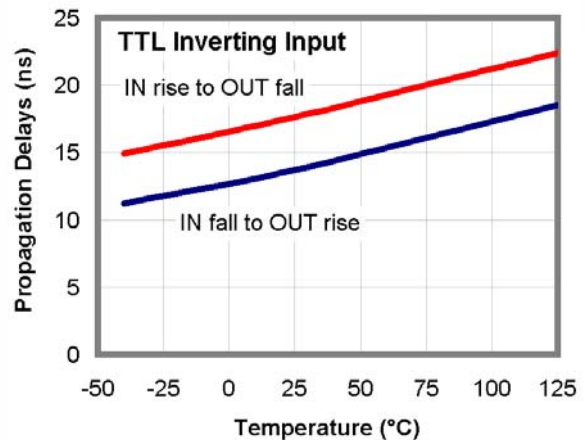

Figure 31. Propagation Delay vs. Temperature

Typical Performance Characteristics

Typical characteristics are provided at 25°C and $V_{DD}=12V$ unless otherwise noted.

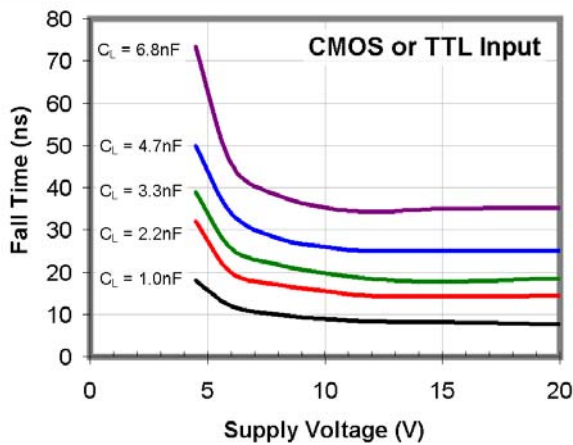

Figure 32. Fall Time vs. Supply Voltage

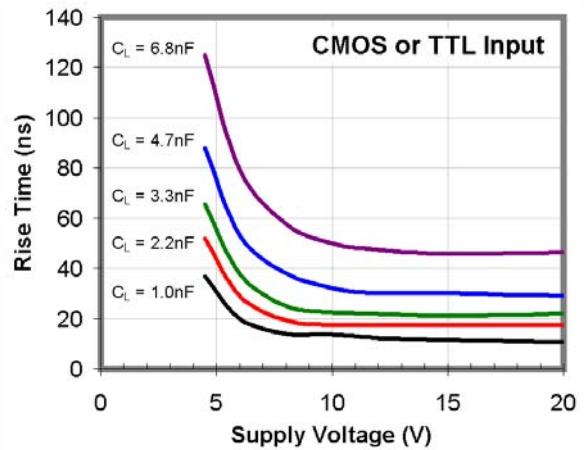

Figure 33. Rise Time vs. Supply Voltage

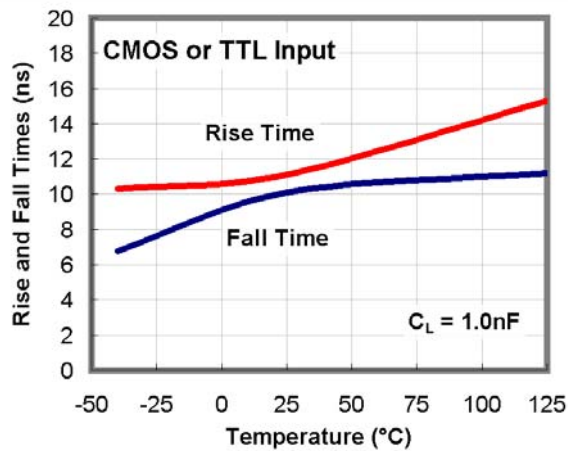

Figure 34. Rise and Fall Time vs. Temperature

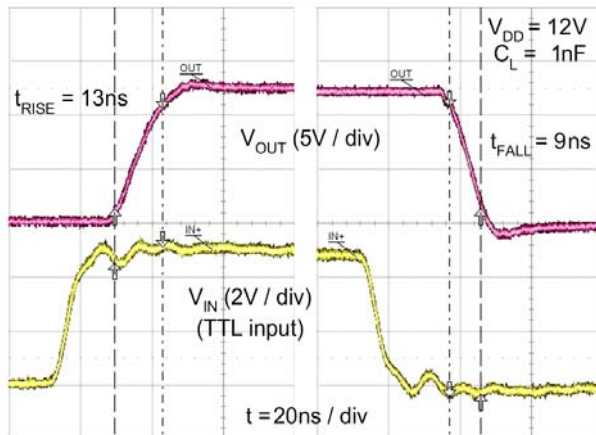

Figure 35. Rise / Fall Waveforms with 1nF Load

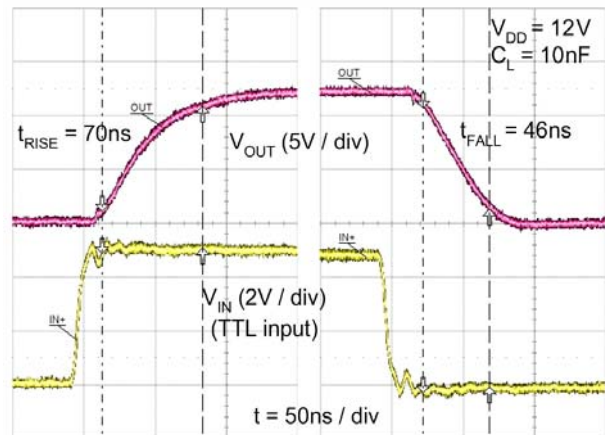

Figure 36. Rise / Fall Waveforms with 10nF Load

Typical Performance Characteristics

Typical characteristics are provided at 25°C and $V_{DD}=12V$ unless otherwise noted.

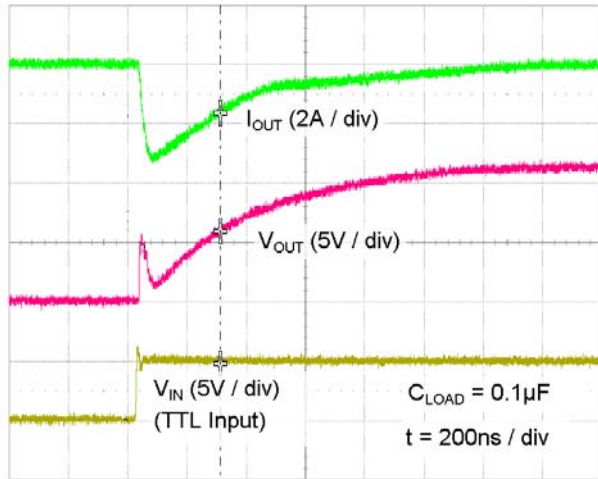

Figure 37. Quasi-Static Source Current with $V_{DD}=12V$

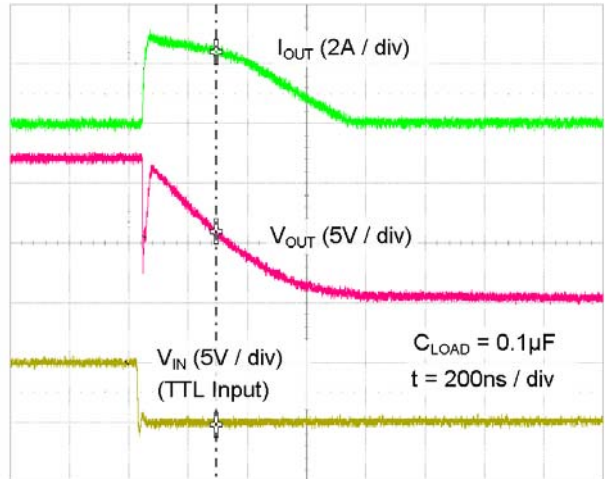

Figure 38. Quasi-Static Sink Current with $V_{DD}=12V$

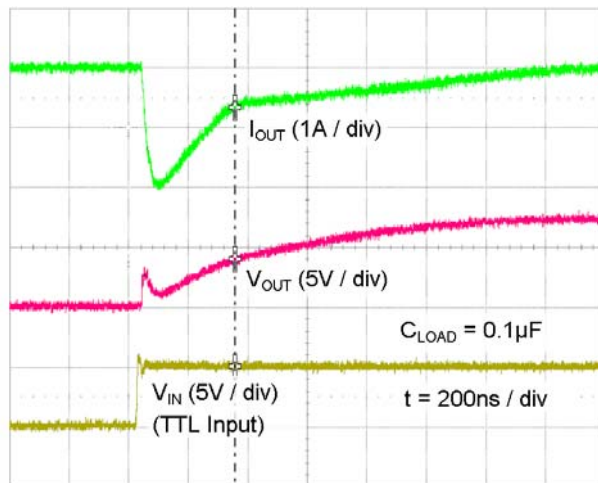

Figure 39. Quasi-Static Source Current with $V_{DD}=8V$

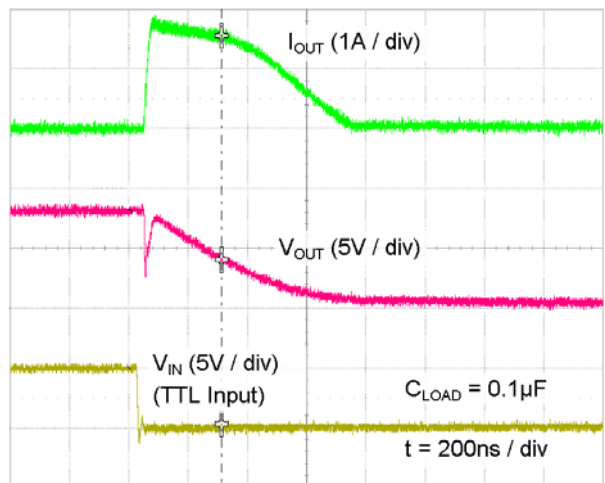

Figure 40. Quasi-Static Sink Current with $V_{DD}=8V$

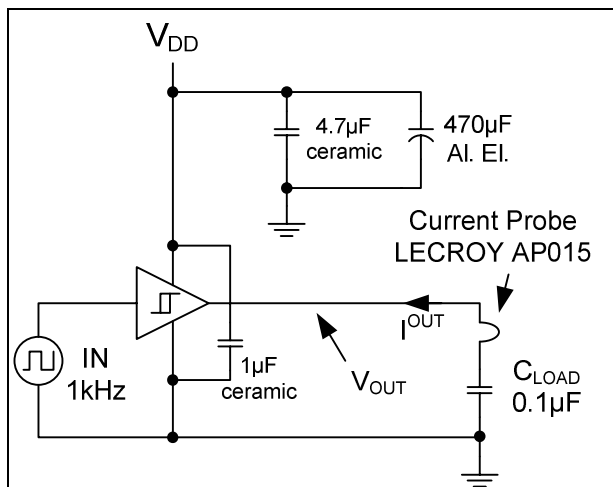

Figure 41. Quasi-Static I_{OUT} / V_{OUT} Test Circuit

Applications Information

Input Thresholds

The FAN3100 offers TTL or CMOS input thresholds. In the FAN3100T, the input thresholds meet industry-standard TTL logic thresholds, independent of the V_{DD} voltage, and there is a hysteresis voltage of approximately 0.4V. These levels permit the inputs to be driven from a range of input logic signal levels for which a voltage over 2V is considered logic high. The driving signal for the TTL inputs should have fast rising and falling edges with a slew rate of $6V/\mu s$ or faster, so the rise time from 0 to 3.3V should be 550ns or less. With reduced slew rate, circuit noise could cause the driver input voltage to exceed the hysteresis voltage and retrigger the driver input, causing erratic operation.

In the FAN3100C, the logic input thresholds are dependent on the V_{DD} level and, with V_{DD} of 12V, the logic rising edge threshold is approximately 55% of V_{DD} and the input falling edge threshold is approximately 38% of V_{DD} . The CMOS input configuration offers a hysteresis voltage of approximately 17% of V_{DD} . The CMOS inputs can be used with relatively slow edges (approaching DC) if good decoupling and bypass techniques are incorporated in the system design to prevent noise from violating the input voltage hysteresis window. This allows setting precise timing intervals by fitting an R-C circuit between the controlling signal and the IN pin of the driver. The slow rising edge at the IN pin of the driver introduces a delay between the controlling signal and the OUT pin of the driver.

Static Supply Current

In the I_{DD} (static) typical performance graphs (Figure 9 - Figure 10 and Figure 15 - Figure 16), the curve is produced with all inputs floating (OUT is low) and indicates the lowest static I_{DD} current for the tested configuration. For other states, additional current flows through the $100k\Omega$ resistors on the inputs and outputs shown in the block diagrams (see Figure 5 - Figure 6). In these cases, the actual static I_{DD} current is the value obtained from the curves plus this additional current.

MillerDrive™ Gate Drive Technology

FAN3100 drivers incorporate the MillerDrive™ architecture shown in Figure 42 for the output stage, a combination of bipolar and MOS devices capable of providing large currents over a wide range of supply voltage and temperature variations. The bipolar devices carry the bulk of the current as OUT swings between $1/3$ to $2/3 V_{DD}$ and the MOS devices pull the output to the high or low rail.

The purpose of the MillerDrive™ architecture is to speed up switching by providing the highest current during the Miller plateau region when the gate-drain capacitance of the MOSFET is being charged or discharged as part of the turn-on / turn-off process. For applications that have zero voltage switching during the MOSFET turn-on or turn-off interval, the driver supplies high peak current for fast switching even though the Miller plateau is not present. This situation often occurs in synchronous rectifier applications

because the body diode is generally conducting before the MOSFET is switched on.

The output pin slew rate is determined by V_{DD} voltage and the load on the output. It is not user adjustable, but if a slower rise or fall time at the MOSFET gate is needed, a series resistor can be added.

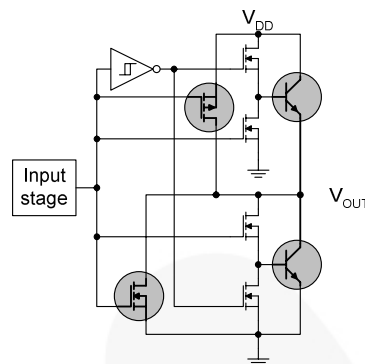

Figure 42. MillerDrive™ Output Architecture

Under-Voltage Lockout

The FAN3100 start-up logic is optimized to drive ground referenced N-channel MOSFETs with an under-voltage lockout (UVLO) function to ensure that the IC starts up in an orderly fashion. When V_{DD} is rising, yet below the 3.9V operational level, this circuit holds the output low, regardless of the status of the input pins. After the part is active, the supply voltage must drop 0.2V before the part shuts down. This hysteresis helps prevent chatter when low V_{DD} supply voltages have noise from the power switching. This configuration is not suitable for driving high-side P-channel MOSFETs because the low output voltage of the driver would turn the P-channel MOSFET on with V_{DD} below 3.9V.

VDD Bypass Capacitor Guidelines

To enable this IC to turn a power device on quickly, a local, high-frequency, bypass capacitor C_{BYP} with low ESR and ESL should be connected between the V_{DD} and GND pins with minimal trace length. This capacitor is in addition to bulk electrolytic capacitance of $10\mu F$ to $47\mu F$ often found on driver and controller bias circuits.

A typical criterion for choosing the value of C_{BYP} is to keep the ripple voltage on the V_{DD} supply $\leq 5\%$. Often this is achieved with a value ≥ 20 times the equivalent load capacitance C_{EQV} , defined here as Q_{gate}/V_{DD} . Ceramic capacitors of $0.1\mu F$ to $1\mu F$ or larger are common choices, as are dielectrics, such as X5R and X7R, which have good temperature characteristics and high pulse current capability.

If circuit noise affects normal operation, the value of C_{BYP} may be increased to 50-100 times the C_{EQV} , or C_{BYP} may be split into two capacitors. One should be a larger value, based on equivalent load capacitance, and the other a smaller value, such as 1-10nF, mounted closest to the V_{DD} and GND pins to carry the higher-frequency components of the current pulses.

Layout and Connection Guidelines

The FAN3100 incorporates fast reacting input circuits, short propagation delays, and powerful output stages capable of delivering current peaks over 2A to facilitate voltage transition times from under 10ns to over 100ns. The following layout and connection guidelines are strongly recommended:

- Keep high-current output and power ground paths separate from logic input signals and signal ground paths. This is especially critical when dealing with TTL-level logic thresholds.
- Keep the driver as close to the load as possible to minimize the length of high-current traces. This reduces the series inductance to improve high-speed switching, while reducing the loop area that can radiate EMI to the driver inputs and other surrounding circuitry.
- The FAN3100 is available in two packages with slightly different pinouts, offering similar performance. In the 6-pin MLP package, Pin 2 is internally connected to the input analog ground and should be connected to power ground, Pin 5, through a short direct path underneath the IC. In the 5-pin SOT23, the internal analog and power ground connections are made through separate, individual bond wires to Pin 2, which should be used as the common ground point for power and control signals.
- Many high-speed power circuits can be susceptible to noise injected from their own output or other external sources, possibly causing output re-triggering. These effects can be especially obvious if the circuit is tested in breadboard or non-optimal circuit layouts with long input, enable, or output leads. For best results, make connections to all pins as short and direct as possible.
- The turn-on and turn-off current paths should be minimized as discussed in the following sections.

Figure 43 shows the pulsed gate drive current path when the gate driver is supplying gate charge to turn the MOSFET on. The current is supplied from the local bypass capacitor, C_{BYP} , and flows through the driver to the MOSFET gate and to ground. To reach the high peak currents possible, the resistance and inductance in the path should be minimized. The localized C_{BYP} acts to contain the high peak current pulses within this driver-MOSFET circuit, preventing them from disturbing the sensitive analog circuitry in the PWM controller.

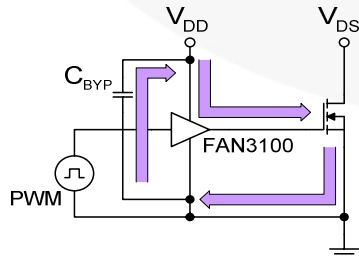

Figure 43. Current Path for MOSFET Turn-On

Figure 44 shows the current path when the gate driver turns the MOSFET off. Ideally, the driver shunts the current directly to the source of the MOSFET in a small circuit loop. For fast turn-off times, the resistance and inductance in this path should be minimized.

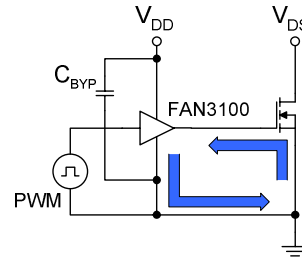

Figure 44. Current Path for MOSFET Turn-Off

Truth Table of Logic Operation

The FAN3100 truth table indicates the operational states using the dual-input configuration. In a non-inverting driver configuration, the IN- pin should be a logic low signal. If the IN- pin is connected to logic high, a disable function is realized, and the driver output remains low regardless of the state of the IN+ pin.

IN+	IN-	OUT
0	0	0
0	1	0
1	0	1
1	1	0

In the non-inverting driver configuration in Figure 45, the IN- pin is tied to ground and the input signal (PWM) is applied to IN+ pin. The IN- pin can be connected to logic high to disable the driver and the output remains low, regardless of the state of the IN+ pin.

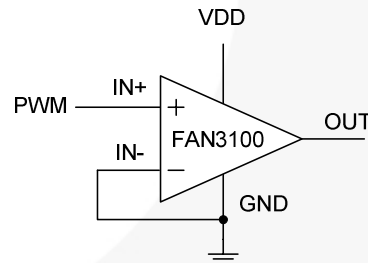

Figure 45. Dual-Input Driver Enabled, Non-Inverting Configuration

In the inverting driver application shown in Figure 46, the IN+ pin is tied high. Pulling the IN+ pin to GND forces the output low, regardless of the state of the IN- pin.

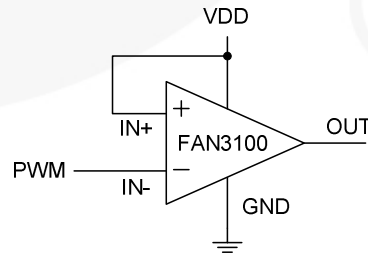

Figure 46. Dual-Input Driver Enabled, Inverting Configuration

Operational Waveforms

At power up, the driver output remains low until the V_{DD} voltage reaches the turn-on threshold. The magnitude of the OUT pulses rises with V_{DD} until steady-state V_{DD} is reached. The non-inverting operation illustrated in Figure 47 shows that the output remains low until the UVLO threshold is reached, then the output is in-phase with the input.

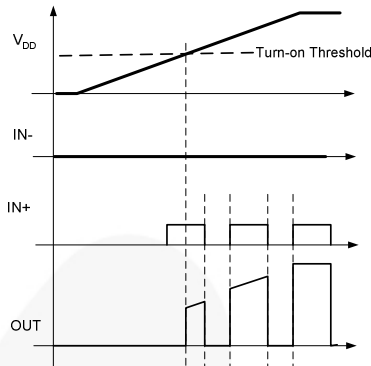

Figure 47. Non-Inverting Start-Up Waveforms

For the inverting configuration of Figure 46, start-up waveforms are shown in Figure 48. With $IN+$ tied to V_{DD} and the input signal applied to $IN-$, the OUT pulses are inverted with respect to the input. At power up, the inverted output remains low until the V_{DD} voltage reaches the turn-on threshold, then it follows the input with inverted phase.

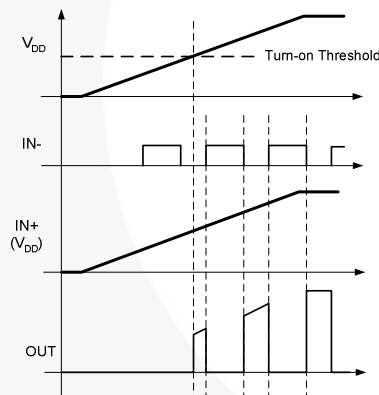

Figure 48. Inverting Start-Up Waveforms

Thermal Guidelines

Gate drivers used to switch MOSFETs and IGBTs at high frequencies can dissipate significant amounts of power. It is important to determine the driver power dissipation and the resulting junction temperature in the application to ensure that the part is operating within acceptable temperature limits.

The total power dissipation in a gate driver is the sum of two components; P_{GATE} and $P_{DYNAMIC}$:

$$P_{TOTAL} = P_{GATE} + P_{DYNAMIC} \quad (1)$$

Gate Driving Loss: The most significant power loss results from supplying gate current (charge per unit time) to switch the load MOSFET on and off at the switching frequency. The power dissipation that results from driving a MOSFET at a specified gate-

source voltage, V_{GS} , with gate charge, Q_G , at switching frequency, f_{SW} , is determined by:

$$P_{GATE} = Q_G \cdot V_{GS} \cdot F_{SW} \quad (2)$$

Dynamic Pre-drive / Shoot-through Current: A power loss resulting from internal current consumption under dynamic operating conditions, including pin pull-up / pull-down resistors, can be obtained using the I_{DD} (no-Load) vs. Frequency graphs in Typical Performance Characteristics to determine the current $I_{DYNAMIC}$ drawn from V_{DD} under actual operating conditions:

$$P_{DYNAMIC} = I_{DYNAMIC} \cdot V_{DD} \quad (3)$$

Once the power dissipated in the driver is determined, the driver junction rise with respect to circuit board can be evaluated using the following thermal equation, assuming Ψ_{JB} was determined for a similar thermal design (heat sinking and air flow):

$$T_J = P_{TOTAL} \cdot \Psi_{JB} + T_B \quad (4)$$

where:

T_J = driver junction temperature

Ψ_{JB} = (psi) thermal characterization parameter relating temperature rise to total power dissipation

T_B = board temperature in location defined in the Thermal Characteristics table.

In a typical forward converter application with 48V input, as shown in Figure 49, the FDS2672 would be a potential MOSFET selection. The typical gate charge would be 32nC with $V_{GS} = V_{DD} = 10V$. Using a TTL input driver at a switching frequency of 500kHz, the total power dissipation can be calculated as:

$$P_{GATE} = 32nC \cdot 10V \cdot 500kHz = 0.160W \quad (5)$$

$$P_{DYNAMIC} = 8mA \cdot 10V = 0.080W \quad (6)$$

$$P_{TOTAL} = 0.24W \quad (7)$$

The 5-pin SOT23 has a junction-to-lead thermal characterization parameter $\Psi_{JB} = 51^\circ C/W$.

In a system application, the localized temperature around the device is a function of the layout and construction of the PCB along with airflow across the surfaces. To ensure reliable operation, the maximum junction temperature of the device must be prevented from exceeding the maximum rating of $150^\circ C$; with 80% derating, T_J would be limited to $120^\circ C$. Rearranging Equation 4 determines the board temperature required to maintain the junction temperature below $120^\circ C$:

$$T_{B,MAX} = T_J - P_{TOTAL} \cdot \Psi_{JB} \quad (8)$$

$$T_{B,MAX} = 120^\circ C - 0.24W \cdot 51^\circ C/W = 108^\circ C \quad (9)$$

For comparison purposes, replace the 5-pin SOT23 used in the previous example with the 6-pin MLP package with $\Psi_{JB} = 2.8^\circ C/W$. The 6-pin MLP package can operate at a PCB temperature of $119^\circ C$, while maintaining the junction temperature below $120^\circ C$. This illustrates that the physically smaller MLP package with thermal pad offers a more conductive path to remove the heat from the driver. Consider the tradeoffs between reducing overall circuit size with junction temperature reduction for increased reliability.

Typical Application Diagrams

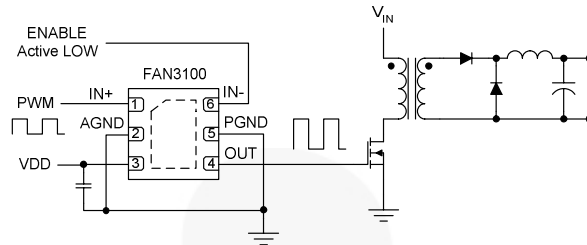

Figure 49. Forward Converter, Primary-Side Gate Drive (MLP Package Shown)

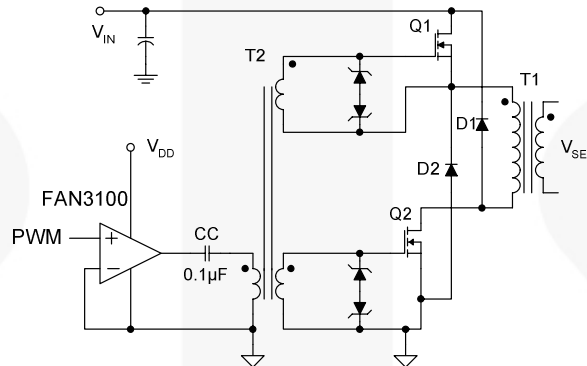

Figure 50. Driver for Two-Transistor Forward Converter Gate Transformer

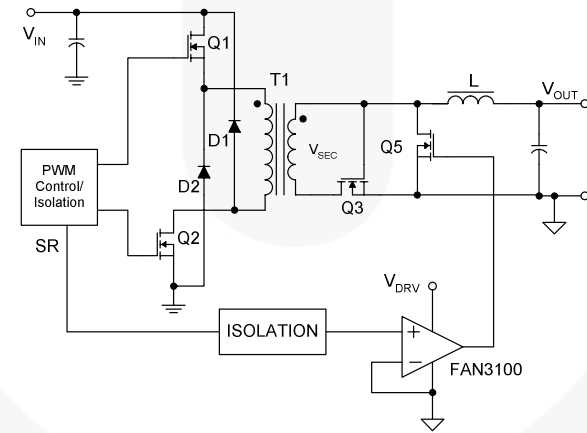

Figure 51. Secondary Synchronous Rectifier Driver

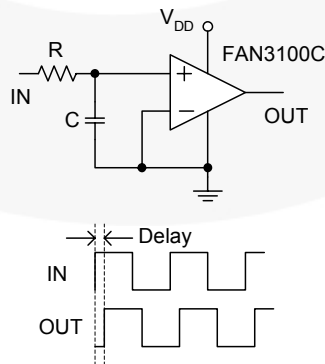

Figure 52. Programmable Time Delay Using CMOS Input

Table 1. Related Products

Part Number	Type	Gate Drive ⁽¹¹⁾ (Sink/Src)	Input Threshold	Logic	Package
FAN3100C	Single 2A	+2.5A / -1.8A	CMOS	Single Channel of Two-Input/One-Output	SOT23-5, MLP6
FAN3100T	Single 2A	+2.5A / -1.8A	TTL	Single Channel of Two-Input/One-Output	SOT23-5, MLP6
FAN3226C	Dual 2A	+2.4A / -1.6A	CMOS	Dual Inverting Channels + Dual Enable	SOIC8, MLP8
FAN3226T	Dual 2A	+2.4A / -1.6A	TTL	Dual Inverting Channels + Dual Enable	SOIC8, MLP8
FAN3227C	Dual 2A	+2.4A / -1.6A	CMOS	Dual Non-Inverting Channels + Dual Enable	SOIC8, MLP8
FAN3227T	Dual 2A	+2.4A / -1.6A	TTL	Dual Non-Inverting Channels + Dual Enable	SOIC8, MLP8
FAN3228C	Dual 2A	+2.4A / -1.6A	CMOS	Dual Channels of Two-Input/One-Output, Pin Config.1	SOIC8, MLP8
FAN3228T	Dual 2A	+2.4A / -1.6A	TTL	Dual Channels of Two-Input/One-Output, Pin Config.1	SOIC8, MLP8
FAN3229C	Dual 2A	+2.4A / -1.6A	CMOS	Dual Channels of Two-Input/One-Output, Pin Config.2	SOIC8, MLP8
FAN3229T	Dual 2A	+2.4A / -1.6A	TTL	Dual Channels of Two-Input/One-Output, Pin Config.2	SOIC8, MLP8
FAN3223C	Dual 4A	+4.3A / -2.8A	CMOS	Dual Inverting Channels + Dual Enable	SOIC8, MLP8
FAN3223T	Dual 4A	+4.3A / -2.8A	TTL	Dual Inverting Channels + Dual Enable	SOIC8, MLP8
FAN3224C	Dual 4A	+4.3A / -2.8A	CMOS	Dual Non-Inverting Channels + Dual Enable	SOIC8, MLP8
FAN3224T	Dual 4A	+4.3A / -2.8A	TTL	Dual Non-Inverting Channels + Dual Enable	SOIC8, MLP8
FAN3225C	Dual 4A	+4.3A / -2.8A	CMOS	Dual Channels of Two-Input/One-Output	SOIC8, MLP8
FAN3225T	Dual 4A	+4.3A / -2.8A	TTL	Dual Channels of Two-Input/One-Output	SOIC8, MLP8

Note:

11. Typical currents with OUT at 6V and $V_{DD} = 12V$.

Physical Dimensions

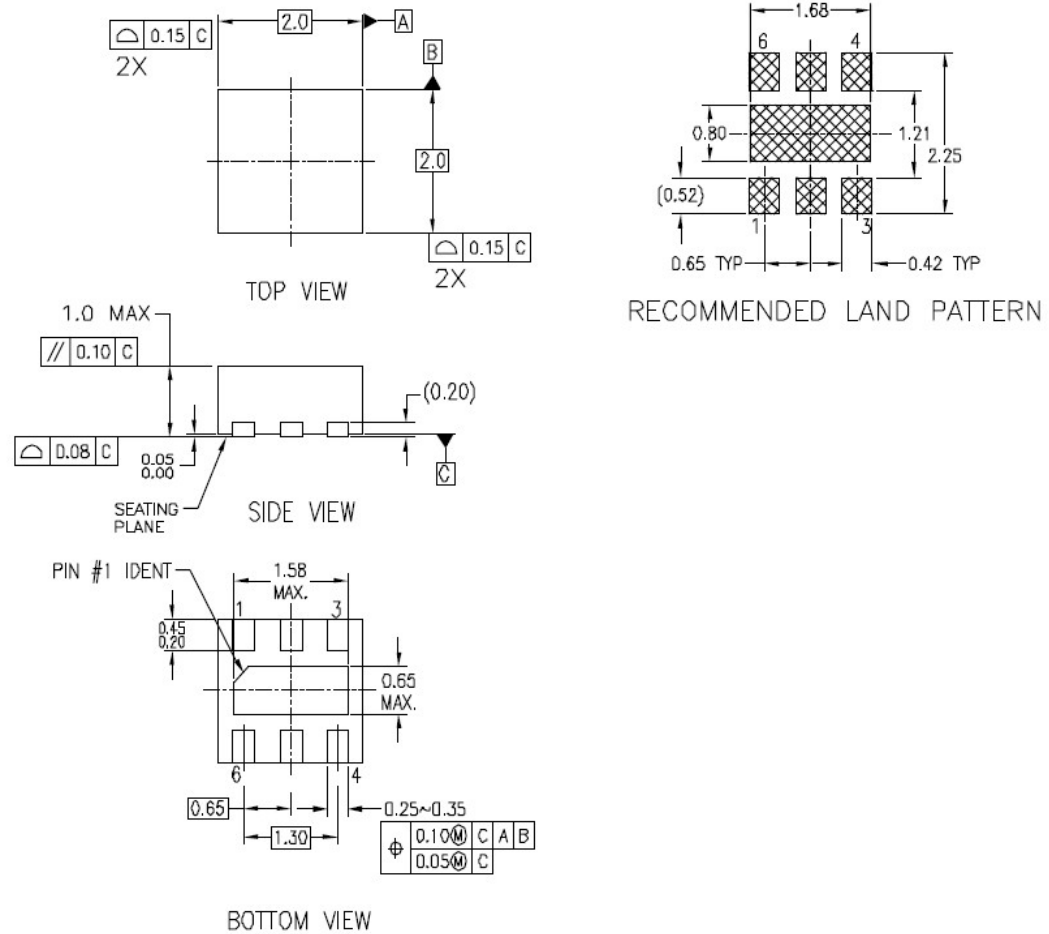

NOTES:

- A. CONFORMS TO JEDEC REGISTRATION MO-229, VARIATION VCCC, DATED 11/2001
- B. DIMENSIONS ARE IN MILLIMETERS.
- C. DIMENSIONS AND TOLERANCES PER ASME Y14.5M, 1994

MLP06BrevA

Figure 53. 2x2mm, 6-Lead Molded Leadless Package (MLP)

Package drawings are provided as a service to customers considering Fairchild components. Drawings may change in any manner without notice. Please note the revision and/or date on the drawing and contact a Fairchild Semiconductor representative to verify or obtain the most recent revision. Package specifications do not expand the terms of Fairchild's worldwide terms and conditions, specifically the warranty therein, which covers Fairchild products.

Always visit Fairchild Semiconductor's online packaging area for the most recent package drawings:
<http://www.fairchildsemi.com/packaging/>

Physical Dimensions (Continued)

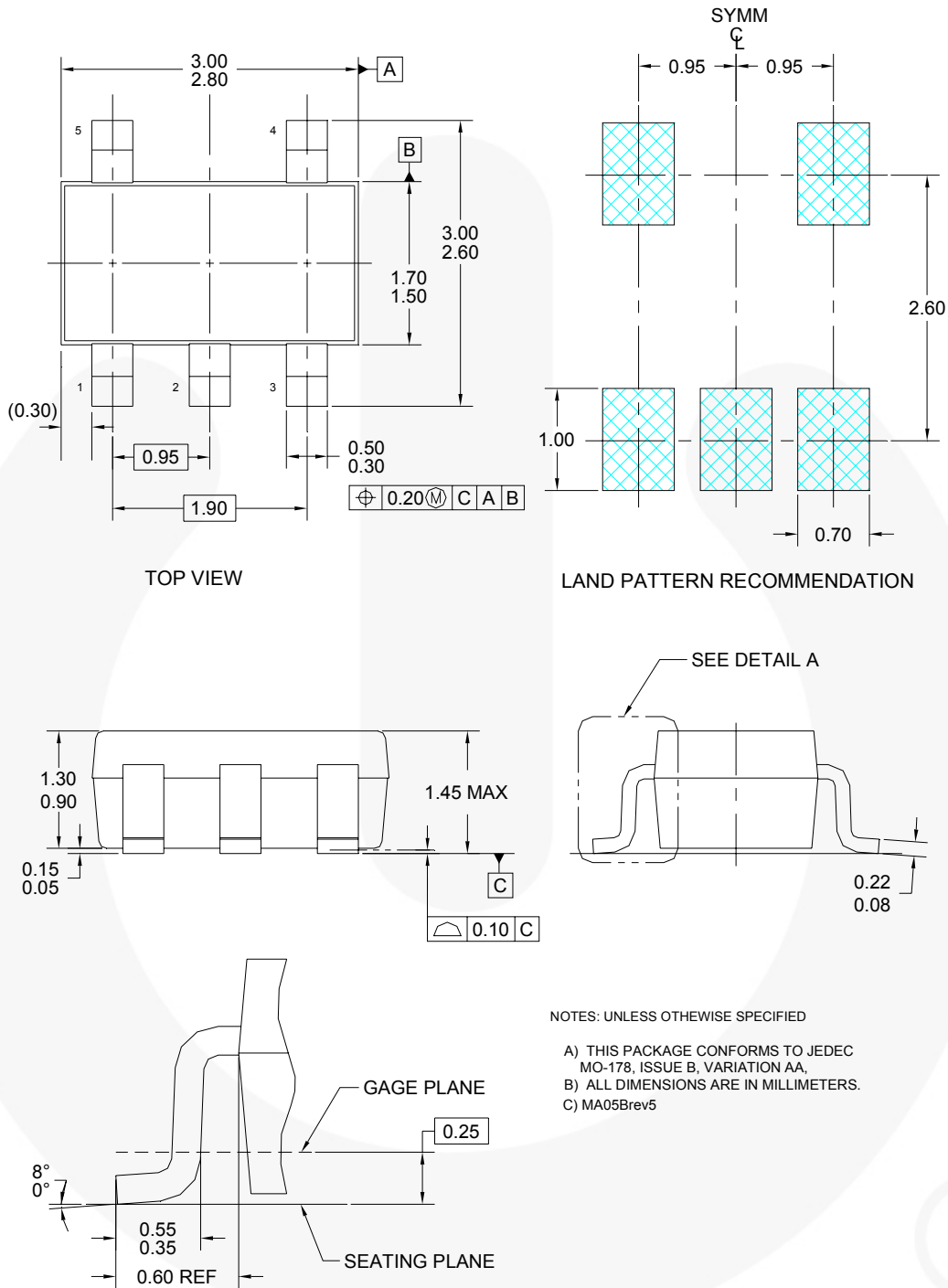

Figure 54. 5-Lead SOT-23

Package drawings are provided as a service to customers considering Fairchild components. Drawings may change in any manner without notice. Please note the revision and/or date on the drawing and contact a Fairchild Semiconductor representative to verify or obtain the most recent revision. Package specifications do not expand the terms of Fairchild's worldwide terms and conditions, specifically the warranty therein, which covers Fairchild products.

Always visit Fairchild Semiconductor's online packaging area for the most recent package drawings:
<http://www.fairchildsemi.com/packaging/>



TRADEMARKS

The following includes registered and unregistered trademarks and service marks, owned by Fairchild Semiconductor and/or its global subsidiaries, and is not intended to be an exhaustive list of all such trademarks.

Build it Now™
CorePLUS™
CorePOWER™
CROSSVOLT™
CTL™
Current Transfer Logic™
EcoSPARK®
EfficientMax™
EZSWITCH™ *
™
®
Fairchild®
Fairchild Semiconductor®
FACT Quiet Series™
FACT®
FAST®
FastvCore™
FlashWriter® *
FPS™
F-PFS™

FRFET®
Global Power Resource SM
Green FPST™
Green FPST™ e-Series™
GTO™
IntelliMAX™
ISOPLANAR™
MegaBuck™
MICROCOUPLER™
MicroFET™
MicroPak™
MillerDrive™
MotionMax™
Motion-SPM™
OPTOLOGIC®
OPTOPLANAR®
®
PDP SPM™
Power-SPM™
PowerTrench®
PowerXS™

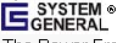
Programmable Active Droop™
QFET®
QS™
Quiet Series™
RapidConfigure™
™
Saving our world, 1mW/W at a time™
SmartMax™
SMART START™
SPM®
STEALTH™
SuperFET™
SuperSOT™.3
SuperSOT™.6
SuperSOT™.8
SupreMOS™
SyncFET™
 SYSTEM GENERAL®
The Power Franchise®

the Power Franchise
TinyBoost™
TinyBuck™
TinyLogic®
TINYOPTO™
TinyPower™
TinyPWM™
TinyWire™
µSerDes™
 SerDes®
UHC®
Ultra FRFET™
UniFET™
VCX™
VisualMax™
XS™

* EZSWITCH™ and FlashWriter® are trademarks of System General Corporation, used under license by Fairchild Semiconductor.

DISCLAIMER

FAIRCHILD SEMICONDUCTOR RESERVES THE RIGHT TO MAKE CHANGES WITHOUT FURTHER NOTICE TO ANY PRODUCTS HEREIN TO IMPROVE RELIABILITY, FUNCTION, OR DESIGN. FAIRCHILD DOES NOT ASSUME ANY LIABILITY ARISING OUT OF THE APPLICATION OR USE OF ANY PRODUCT OR CIRCUIT DESCRIBED HEREIN; NEITHER DOES IT CONVEY ANY LICENSE UNDER ITS PATENT RIGHTS, NOR THE RIGHTS OF OTHERS. THESE SPECIFICATIONS DO NOT EXPAND THE TERMS OF FAIRCHILD'S WORLDWIDE TERMS AND CONDITIONS, SPECIFICALLY THE WARRANTY THEREIN, WHICH COVERS THESE PRODUCTS.

LIFE SUPPORT POLICY

FAIRCHILD'S PRODUCTS ARE NOT AUTHORIZED FOR USE AS CRITICAL COMPONENTS IN LIFE SUPPORT DEVICES OR SYSTEMS WITHOUT THE EXPRESS WRITTEN APPROVAL OF FAIRCHILD SEMICONDUCTOR CORPORATION.

As used herein:

1. Life support devices or systems are devices or systems which, (a) are intended for surgical implant into the body or (b) support or sustain life, and (c) whose failure to perform when properly used in accordance with instructions for use provided in the labeling, can be reasonably expected to result in a significant injury of the user.
2. A critical component in any component of a life support, device, or system whose failure to perform can be reasonably expected to cause the failure of the life support device or system, or to affect its safety or effectiveness.

ANTI-COUNTERFEITING POLICY

Fairchild Semiconductor Corporation's Anti-Counterfeiting Policy. Fairchild's Anti-Counterfeiting Policy is also stated on our external website, www.fairchildsemi.com, under Sales Support.

Counterfeiting of semiconductor parts is a growing problem in the industry. All manufacturers of semiconductor products are experiencing counterfeiting of their parts. Customers who inadvertently purchase counterfeit parts experience many problems such as loss of brand reputation, substandard performance, failed applications, and increased cost of production and manufacturing delays. Fairchild is taking strong measures to protect ourselves and our customers from the proliferation of counterfeit parts. Fairchild strongly encourages customers to purchase Fairchild parts either directly from Fairchild or from Authorized Fairchild Distributors who are listed by country on our web page cited above. Products customers buy either from Fairchild directly or from Authorized Fairchild Distributors are genuine parts, have full traceability, meet Fairchild's quality standards for handling and storage and provide access to Fairchild's full range of up-to-date technical and product information. Fairchild and our Authorized Distributors will stand behind all warranties and will appropriately address any warranty issues that may arise. Fairchild will not provide any warranty coverage or other assistance for parts bought from Unauthorized Sources. Fairchild is committed to combat this global problem and encourage our customers to do their part in stopping this practice by buying direct or from authorized distributors.

PRODUCT STATUS DEFINITIONS

Definition of Terms

Datasheet Identification	Product Status	Definition
Advance Information	Formative / In Design	Datasheet contains the design specifications for product development. Specifications may change in any manner without notice.
Preliminary	First Production	Datasheet contains preliminary data; supplementary data will be published at a later date. Fairchild Semiconductor reserves the right to make changes at any time without notice to improve design.
No Identification Needed	Full Production	Datasheet contains final specifications. Fairchild Semiconductor reserves the right to make changes at any time without notice to improve the design.
Obsolete	Not In Production	Datasheet contains specifications on a product that is discontinued by Fairchild Semiconductor. The datasheet is for reference information only.

Rev. 137